

Spectrum Brands

REMINGTON  Russell Hobbs

united
INDUSTRIES

 **VARTA**



Hardware &
Home Improvement

RAYOVAC

Presentation to

**Deutsche Bank 11th Annual
Global Consumer Conference**

June 17, 2014 – Paris

Dave Lumley
Chief Executive Officer

Tony Genito
Executive Vice President and CFO

Forward-Looking Statements

Certain matters discussed in this presentation, with the exception of historical matters, may be forward-looking statements within the meaning of the Private Securities Litigation Reform Act of 1995. All statements, other than statements of historical facts, regarding our business strategy, future operations, financial condition, estimated revenues, projected costs, projected synergies, prospects, plans and objectives of management, as well as information concerning expected actions of third parties, are forward-looking statements. These statements are subject to a number of risks and uncertainties that could cause results to differ materially from those anticipated as of the date of this presentation. Important factors that could cause our actual results to differ materially from those expressed or implied herein include, without limitation: our ability to manage and otherwise comply with our covenants with respect to our significant outstanding indebtedness or maintain our credit ratings; changes and developments in external competitive market factors, such as introduction of new product features or technological developments; development of new competitors or competitive brands or competitive promotional activity or spending or industry consolidation; the cost and effect of unanticipated legal, tax or regulatory proceedings or new accounting policies, laws or regulations (including environmental, public health and consumer protection regulations); seasonality of our products and changes in consumer demand for the various types of products we offer resulting in the loss of, or a significant reduction in, sales to significant retail customers; our ability to develop and successfully introduce new products, protect our intellectual property and avoid infringing the intellectual property of third parties; public perception regarding the safety of our products, including the potential for environmental liabilities, product liability claims, litigation and other claims; unfavorable developments in the global credit markets; the impact of overall economic conditions, terrorist attacks, acts of war or other unrest in international markets on consumer spending; fluctuations in commodities prices, supply shortages, the costs or availability of raw materials or terms and conditions available from suppliers; changes in the general economic conditions in countries and regions where we do business, such as stock market prices, interest rates, currency exchange rates, inflation and consumer spending; our ability to successfully implement manufacturing, distribution and other cost efficiencies and to continue to benefit from our cost-cutting initiatives; the impact of expenses resulting from the implementation of new business strategies, divestitures or restructuring activities; our ability to integrate, and to realize synergies from, the combined businesses of Spectrum Brands, Inc. and Russell Hobbs, Inc.; our ability to identify, develop and retain key employees; unfavorable weather conditions or climate change and various other risks and uncertainties, including those discussed herein and those set forth in our filings with the Securities and Exchange Commission (“SEC”).

We also caution the reader that undue reliance should not be placed on any forward-looking statements, which speak only as of the date of this presentation. We undertake no duty or responsibility to update any of these forward-looking statements to reflect events or circumstances after the date of this presentation or to reflect actual outcomes. Additional factors that may affect future results and conditions are described in our filings with the SEC, which are available at the SEC’s web site at www.sec.gov or at Spectrum Brands’ website at www.spectrumbrands.com. The information contained in this presentation is summary information that is intended to be considered in the context of our SEC filings, and other public announcements that we may make, by press release or otherwise, from time to time. In addition, information related to past performance, while helpful as an evaluative tool, is not necessarily indicative of future results, the achievement of which cannot be assured. You should not view our past performance, or information about the market, as indicative of our future results. Further, performance information respecting investment returns on portfolio transactions is not directly equivalent to returns on an investment in our common stock.

Reconciliation of Non-GAAP Financial Measurements

Management believes that certain non-GAAP financial measures may be useful in certain instances to provide additional meaningful comparisons between current results and results in prior operating periods. Excluding the impact of current exchange rate fluctuations may provide additional meaningful reflection of underlying business trends. In addition, within this presentation, including the tables that follow, reference is made to adjusted earnings before interest, taxes, depreciation and amortization (EBITDA), free cash flow and adjusted gross profit.

Adjusted EBITDA is a metric used by management and frequently used by the financial community which provides insight into an organization's operating trends and facilitates comparisons between peer companies, because interest, taxes, depreciation and amortization can differ greatly between organizations as a result of differing capital structures and tax strategies. Adjusted EBITDA can also be a useful measure of a company's ability to service debt and is one of the measures used for determining the Company's debt covenant compliance. Adjusted EBITDA excludes certain items that are unusual in nature or not comparable from period to period.

In addition, the Spectrum Brands' management uses adjusted gross profit as one means of analyzing the Spectrum Brands' current and future financial performance and identifying trends in its financial condition and results of operations. Management believes that adjusted gross profit is a useful measure for providing further insight into Spectrum Brands' operating performance because it eliminates the effects of certain items that are not comparable from one period to the next.

Also, management believes that free cash flow is useful to both management and investors in their analysis of Spectrum Brands' ability to service and repay its debt and meet its working capital requirements. Free cash flow should not be considered in isolation or as a substitute for pretax income (loss), net income (loss), cash provided by (used in) operating activities or other statement of operations or cash flow statement data prepared in accordance with GAAP or as a measure of profitability or liquidity. In addition, the calculation of free cash flow does not reflect cash used to service debt and therefore, does not reflect funds available for investment or discretionary uses.

Spectrum Brands provides this information to investors to assist in comparisons of past, present and future operating results and to assist in highlighting the results of on-going operations. While Spectrum Brands' management believes that non-GAAP measurements are useful supplemental information, such adjusted results are not intended to replace the Spectrum Brands' GAAP financial results and should be read in conjunction with those GAAP results.

All GAAP reconciliations are available at www.spectrumbrands.com

Spectrum Brands Evolution

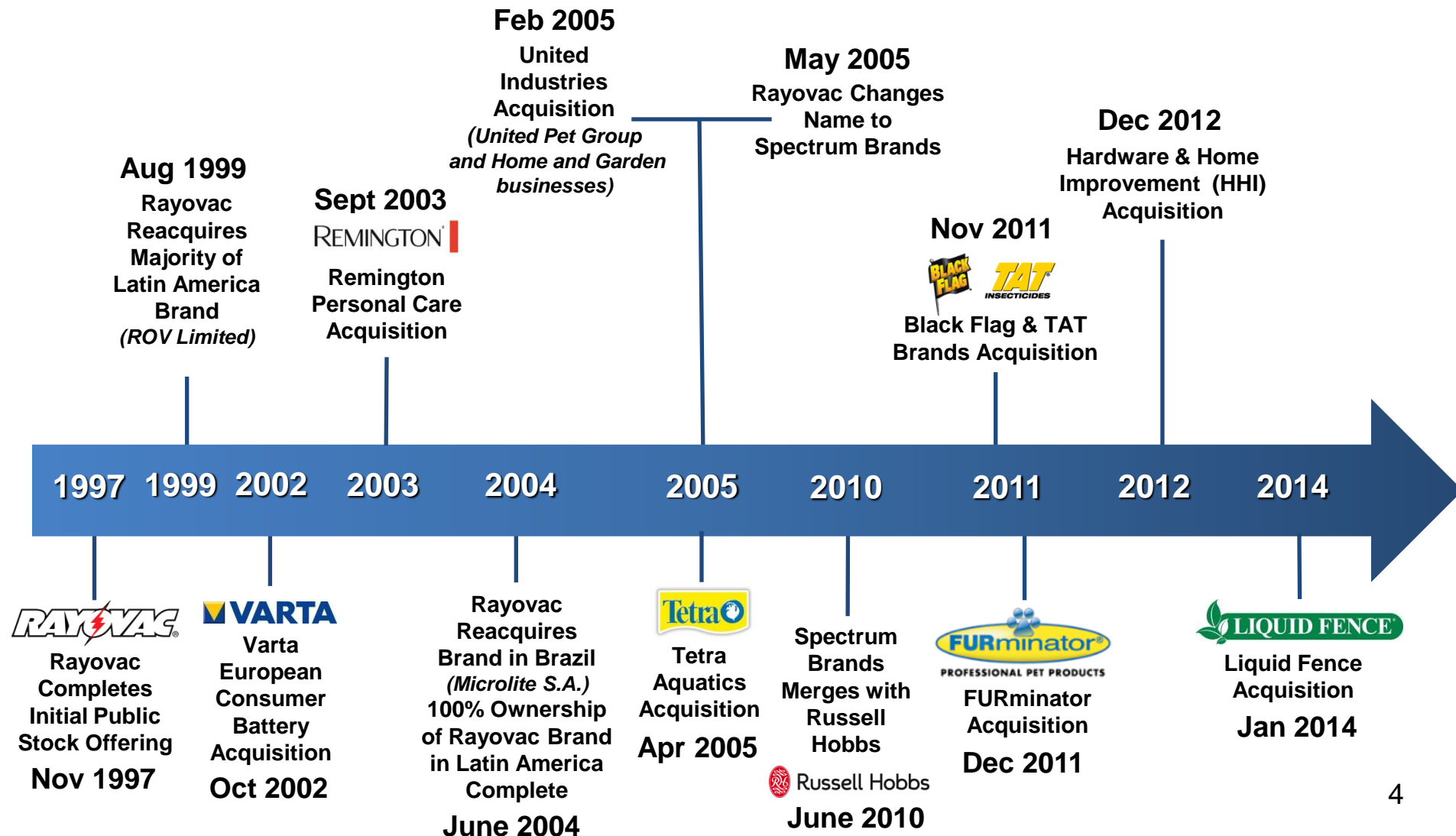

Attractive Segment Profile and Diverse Portfolio of Unrivaled Brands

Global Batteries & Appliances
FY13 Net Sales \$2.20B;
Adj. EBITDA \$304M

GLOBAL BATTERIES

RAYNAG VARTA

PERSONAL Care

REMINGTON

SMALL APPLIANCES

Russell Hobbs FARBERWARE

Toastmaster Breadman

Juiceman

GEORGE FOREMAN
HEALTHY COOKING

BLACK+DECKER

Global Pet Supplies
FY13 Net Sales \$622M;
Adj. EBITDA \$120M

Tetra

NATURE'S
MIRACLE

Instant Ocean

FURminator
PROFESSIONAL PET PRODUCTS

PRO-SENSE

DINGO
Wear in the Middle

MARINELAND

Excel

BIRDOLA
Wildlife feeding specialists

Wild Harvest

Perfect Coat
Every Dog Has Its Perfect Style

Home and Garden
FY13 Net Sales \$391M;
Adj. EBITDA \$90M

Spectracide

REPEL

Real-Kill

HOT SHOT

BLACK FLAG

TAT
INSECTICIDES

Cutter

LIQUID FENCE

Hardware &
Home Improvement (1)
PF FY13 Net Sales \$1.06B;
PF Adj. EBITDA \$181M (2)

Kwikset

WEISER FANAL

BALDWIN

EZSET

STANLEY

National
Hardware

Pfister

Spectrum Brands' portfolio includes widely used, non-discretionary, replacement consumer brands

Note: As of FY13. Adjusted EBITDA excludes \$18 million of corporate/unallocated expenses.

(1) Hardware & Home Improvement was acquired by Spectrum Brands on December 17, 2012 (the first quarter of fiscal 2013).

(2) The pre-acquisition sales and earnings of HHI do not include the TLM Taiwan business as stand alone financial data is not available for the periods presented. The TLM Taiwan business is not deemed material to the Company's operating results.

Spectrum Brands

Providing Quality and Value to Retailers and Consumers Worldwide

- FY13 net sales and adjusted EBITDA of \$4,277 million^(a) and \$677 million^(b), respectively
- Spectrum Brands Value Model drives success of strong, well-recognized and extendable brand names
- Top 3 global market positions in all product categories
- Global footprint with presence on 6 continents and products sold in approximately 140 countries
- Strong relationships with major retailers globally
- Experienced and proven management team

Diverse Portfolio Across Attractive Categories

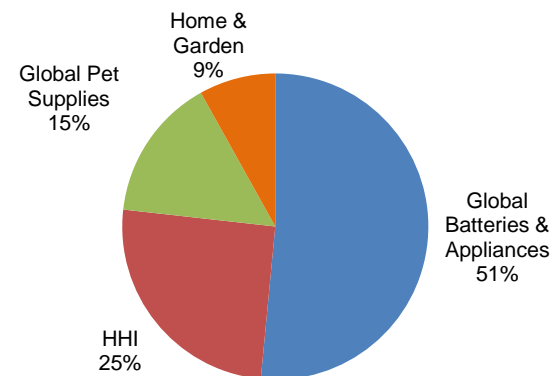

FY13 Net Sales - \$4,277 million^(a)

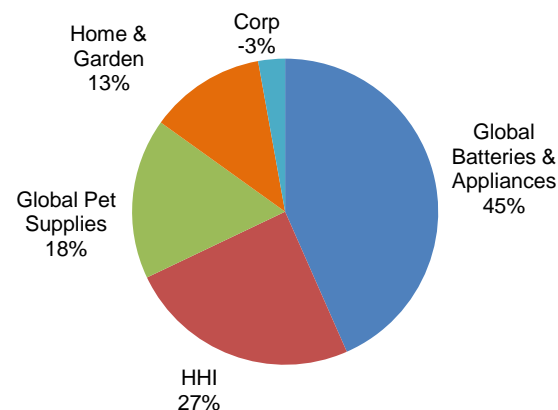

FY13 Adjusted EBITDA - \$677 million^(b)

The “Spectrum Value Model” drives adjusted EBITDA growth

(a) Sales include HHI pro forma as if acquired at beginning of FY13.

(b) Adjusted EBITDA includes \$18 million of corporate/unallocated expenses and HHI pro forma as if acquired at beginning of FY13.

Strong Financial Performance Despite a Challenged Consumer

- Quarter-over-quarter net sales and adjusted EBITDA growth with few exceptions since FY09
- Pet Supplies and Home and Garden led the adjusted EBITDA improvements for FY13
- Drivers of solid financial performance include:
 - Resilient demand for Spectrum Brands products across categories with “superior value” brand positioning
 - Increased distribution/market share in key product segments worldwide
 - Emphasis on continuous improvement, global new product development, efficient operating culture, and strong expense controls
 - Cost-saving initiatives at Spectrum Brands, Russell Hobbs and Global Pet from SKU/brand rationalization and plant/distribution center consolidations
 - Leveraging infrastructure to lower production expense through facility closures/SAP
 - Focus on non-discretionary, non-premium priced, consumer replacement products
- CapEx focus on product development/cost reductions

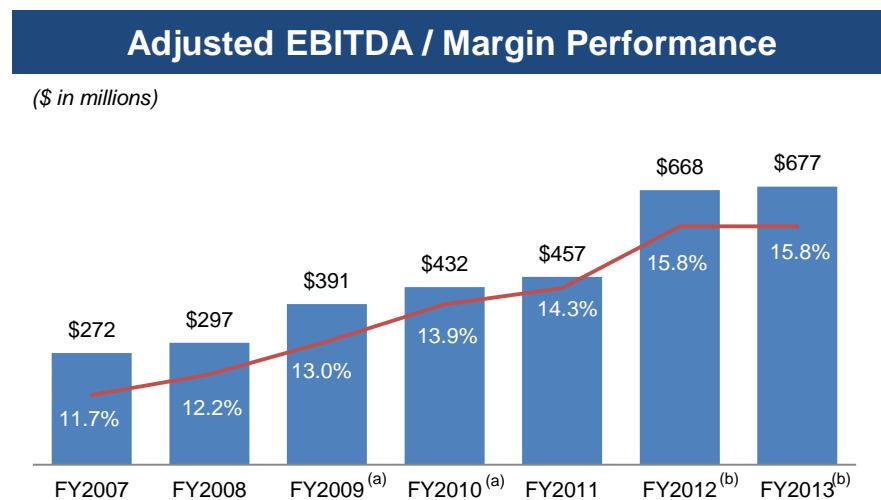
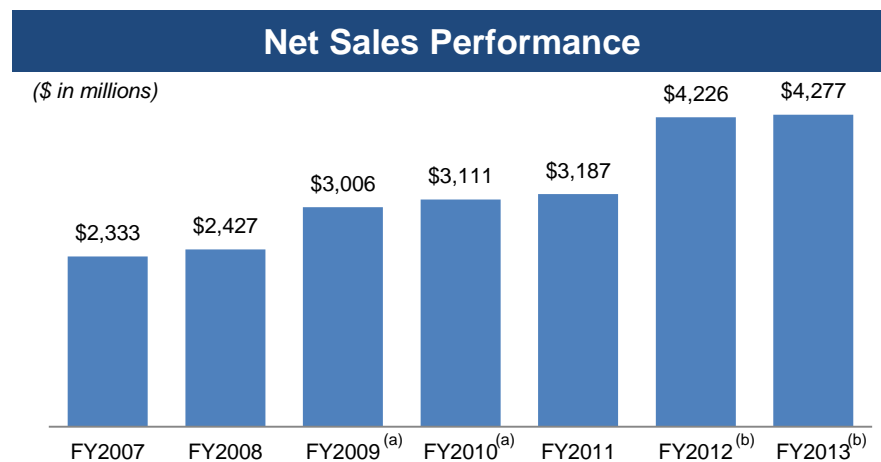

Spectrum Brands has generated robust sales and adjusted EBITDA growth, both organically and by acquisitions

(a) Reflects pro forma as if Russell Hobbs merger completed at beginning of respective period.

(b) Reflects pro forma as if HHI acquired at beginning of respective period.

Record Performance – Q2 FY14 vs. Q2 FY13

Net Sales

(\$ in millions)

Adjusted EBITDA

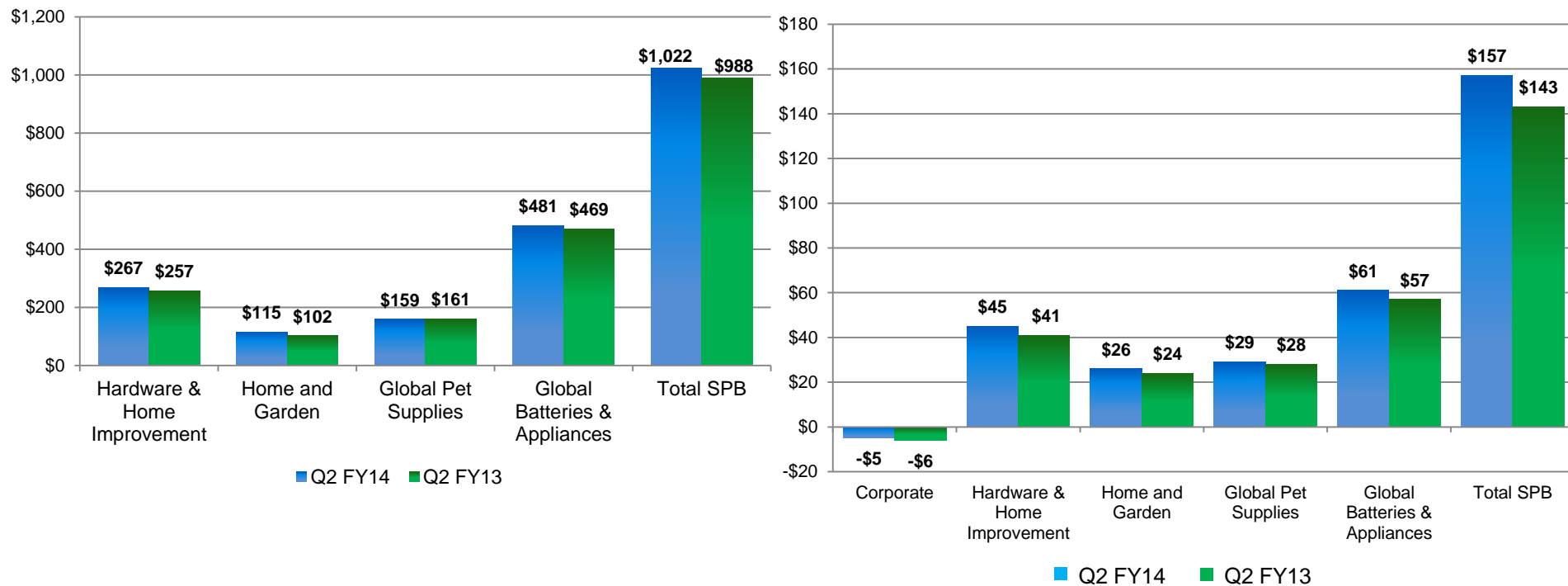

- Net sales increased 3.4 percent (4.0 percent excluding negative FX impact)
- Swung to net income from net loss and adjusted EPS of \$0.72 increased 64 percent
- Adjusted EBITDA of \$157 million increased 11 percent, with adjusted EBITDA margin expansion to 15.3 percent from 14.5 percent
- Solid results from HHI, battery, personal care, and home and garden businesses, strong European results continued, and record Q2 level of continuous improvement savings
- Reiterated plans to reduce term debt by about \$250 million in fiscal 2014

Spectrum Brands Vision

VISION

Be the leader in retailer metrics with superior value consumer products for everyday use

GOAL



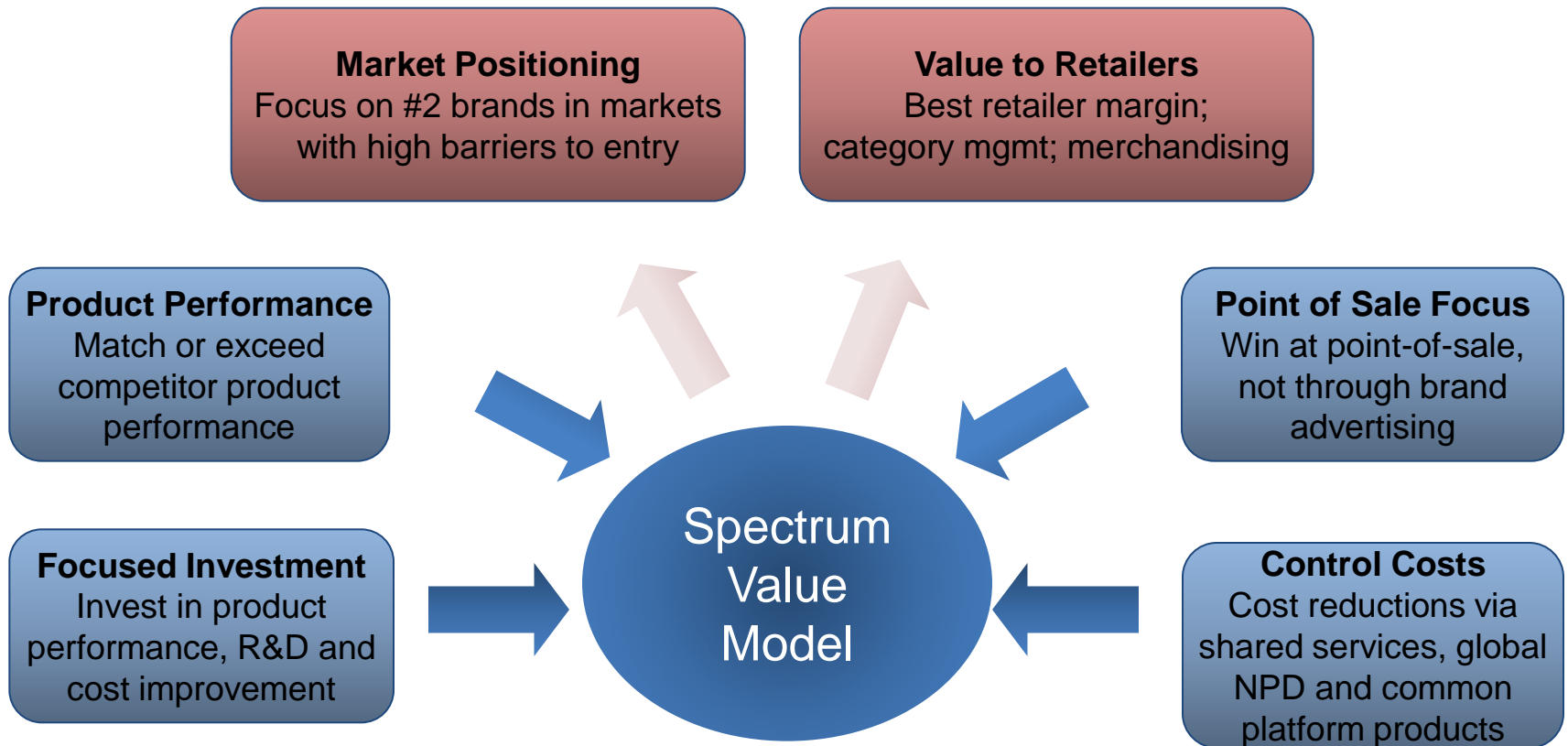

Create shareholder value through adjusted EBITDA and free cash flow growth and debt reduction

Spectrum Value Model: “Same Performance, Less Price / Better Value”



The “Spectrum Value Model” differentiates Spectrum Brands and helps provide stability and sustainable earnings

Leading Market Share and Competitive Brands

Category	Select Key Brands	Market Position
Consumer Batteries	 	#3 (North America) #2 (Europe) #1 (Latin America)
Electric shaving and grooming		#3 (North America, Australia, Europe)
Electrical personal care products		#1 (Australia) #2 (North America, Europe)
Portable lighting	 	#2 (North America, Europe, Latin America)
Kitchen & home products	   	#2 (U.S. kitchen products) #1 (U.S. hand-held irons) #1 (U.K. kitchen/home products)
Pet supplies	    	#2 (Global pet supplies) #1 (Global aquatics)
Home & garden control products	     	#2 (U.S.)
Residential locksets	  	#1 (U.S. locksets) #1 (Canada locksets) #1 (U.S. luxury locksets)
Builders' hardware	   	#1 (U.S. builders' hardware) #2 (Mexico hardware)
Faucets		#4 / #3 in U.S. retail channel

Note: All market size and market position information is per Company estimates and industry data as of January 2014

Diverse and Loyal Customer Base

- Spectrum Brands' largest customer in FY13 accounted for ~17% of sales, with the remainder of its top 10 customers accounting for ~18%
- The Company maintains long-term relationships of more than 20 years with many key customers, including Walmart, Lowe's and Boots
- The Company focuses on providing the best retailer margin, category management and merchandising to maintain and further strengthen its retailer relationships

Customer Breakdown by Revenue in FY13

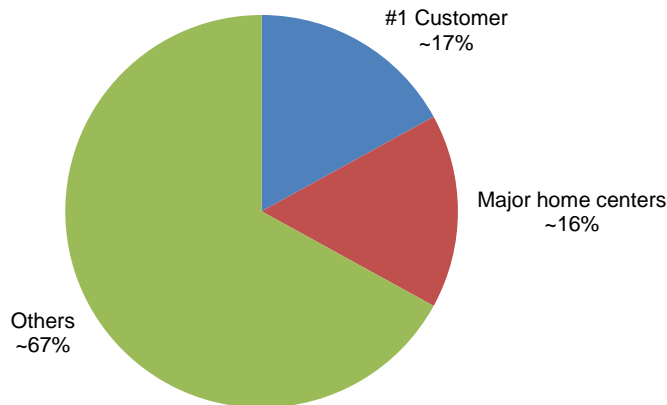

Examples of Key Customers



Growth Strategies

Pursue Select Bolt-On Acquisitions to Further Enhance Scale

Key acquisition priorities

Global Pet Supplies

- Large and rich list of targets identified for bolt-on acquisitions
- Primary focus in companion animals (e.g., FURminator® in Q1FY12)
- Potential acquisition categories include dog and cat treats, dog and cat healthcare, wild bird, dog and cat nutrition, reptile, and pet training and containment
- Seek targets that offer manufacturing and/or distribution synergies
- Fragmented industry is ripe for consolidation

Home and Garden

- Targets focused on small to medium-sized CPG companies in the H&G and cleaning categories
- Seek targets that offer product strategic fit and/or manufacturing and distribution synergies (e.g., Black Flag®/TAT® brand assets in Q1FY12 and Liquid Fence in Q1FY14)
- Complementary brands and categories
- Evaluating liquid and aerosol fill opportunities

Hardware & Home Improvement

- Overall focus on bolt-on home improvement businesses that enhance HHI's emerging technologies, leverage global scale, improve sales and distribution efficiencies through existing channels or add new distribution channels and geographies
- Security: expand technology and global penetration in both residential and commercial markets
- Hardware: synergistic, bolt-on consumable product categories that leverage HHI's distribution and sales capabilities
- Plumbing: primary interest is opportunities that increase channel and geographic diversification and augment manufacturing capabilities

Spectrum Brands continually evaluates synergistic, bolt-on acquisitions to expand its product line, extend market penetration and grow its geographic footprint

Successful Track Record of Acquisition Integration/Delevering

- Track record of using strong free cash flow generation to reduce debt
- Proven integrator – successfully integrated Russell Hobbs, exceeding synergy goals, as well as more recent add-ons FURminator, Black Flag/TAT, HHI and Tong Lung
- Significant NOLs and limited CapEx requirements enhance free cash flow profile
- Spectrum Brands generated FY13 adjusted free cash flow of \$254 million and repaid \$200 million of existing term debt in FY13 with \$570 million of cumulative debt payments over the last three years
- Opportunistic approach to debt refinancing to ensure lowest possible rates on all debt tranches
 - Refinanced \$680 million of term debt in 2011 resulting in approximately \$20 million of annual cash interest savings
 - Refinanced \$245 million of Senior Subordinated toggle notes in 2012 resulting in approximately \$10 million of annual cash interest savings
 - Refinanced \$950 million of 9.5% senior secured notes in 2013 resulting in approximately \$55 million of annual cash interest savings
 - Replaced/repriced \$513 million of existing term debt with \$215 million and €225 million of term debt in Q1FY14 resulting in nearly \$4 million of annual cash interest savings and better alignment of cash inflows with cash outflows related to principal, interest and taxes
- Strong free cash flow should enable Spectrum Brands to delever balance sheet toward long-term total leverage ratio target of 2.5x - 3.5x by end of FY15

Robust Business with Solid Cash Flow Generation

- FY13 free cash flow was a record \$254 million, or about \$5 per share
- FY14 free cash flow expected to be at least \$350 million, or nearly \$7 per share
 - Cash taxes of \$75-85 million (primarily driven by timing of payments and income tax audits from 2007-2010 period); normal run-rate in FY15 and beyond expected to be \$55-60 million
 - CapEx of \$70-75 million, predominantly for cost reduction and new product development, with normal run-rate of \$65-70 million
 - Cash integration/restructuring now expected to approximate \$40 million, which includes HHI, as legacy business charges will continue to decline
 - Cash interest payments of \$170-175 million
- FY15 free cash flow pathway to approximately \$400 million, or nearly \$8 per share, before factoring in any growth in the business

Adjusted EBITDA less capital expenditures ^(a)

(\$ in millions)

■ Pro Forma
■ Legacy

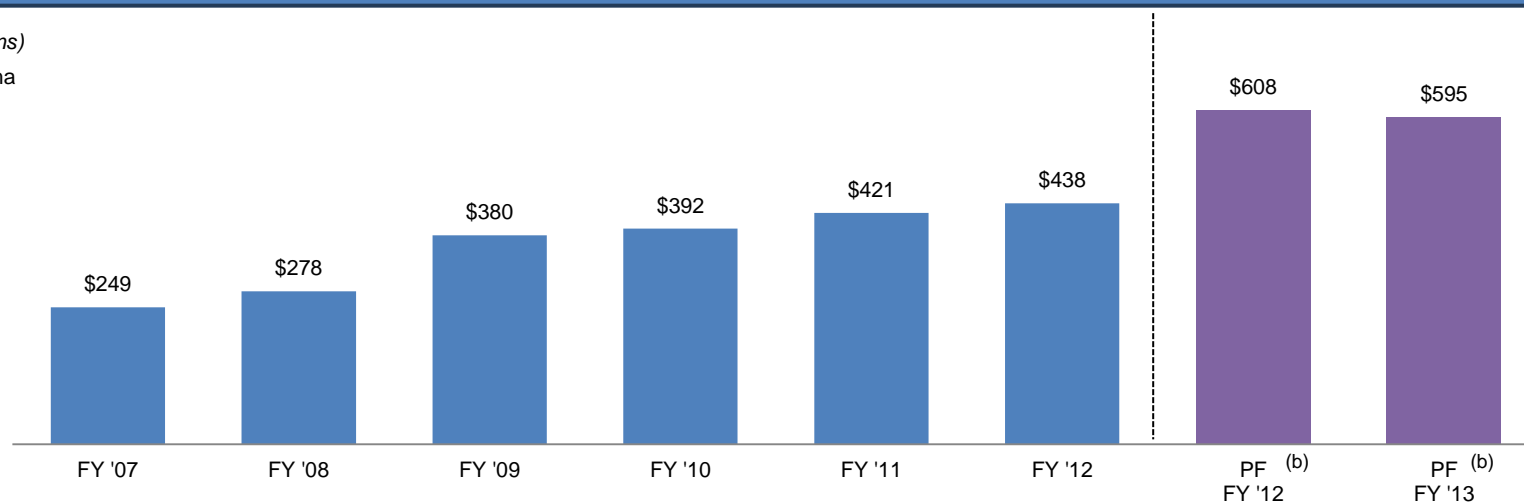

(a) The pre-acquisition earnings and capital expenditures of HHI do not include the TLM Taiwan business as stand alone financial data is not available for the periods presented. The TLM Taiwan business is not deemed material to the Company's operating results.

(b) Reflects pro forma as if HHI acquired at beginning of respective period.

Global Batteries & Appliances (GBA) Segment

REMINGTON®

 Toastmaster®

GEORGE FOREMAN®
HEALTHY COOKING

 **VARTA**

RAYOVAC®

Juiceman®

Breadman®

FARBERWARE®

**BLACK+
DECKER**™



**Russell
Hobbs**

**Global Batteries
& Appliances**



Global Batteries & Appliances Segment

- Operating results driven by Spectrum Value Model
 - Same quality/performance at a lower price
 - Global battery business is increasing its retailer presence/launching new products
 - Battery industry is stable and expected to continue modest annual growth in cell units
 - Device population has stabilized and resumed modest growth
 - Leading global position in hearing aid batteries
 - Appliances business holds market-leading positions in 6 key categories
- Consumers are switching to value brands
 - Experiencing market share gains in many categories around the world
- Large customers gaining share of total market, helping propel share gains
 - Driving foot traffic into big-box retailers
 - Renewed focus on “one-stop shopping”
- Company is capitalizing on its platform with innovation and a stream of new product launches (for example, Hyperflex men’s shave/groom models, i-LIGHT facial hair removal, mill & brew coffee maker, extra wide toaster oven, EvenToast toaster oven, George Foreman grills, irons)
- Strong adjusted EBITDA performance despite soft economy, rising costs from Asian suppliers and volatile FX

Adjusted EBITDA Performance - GBA

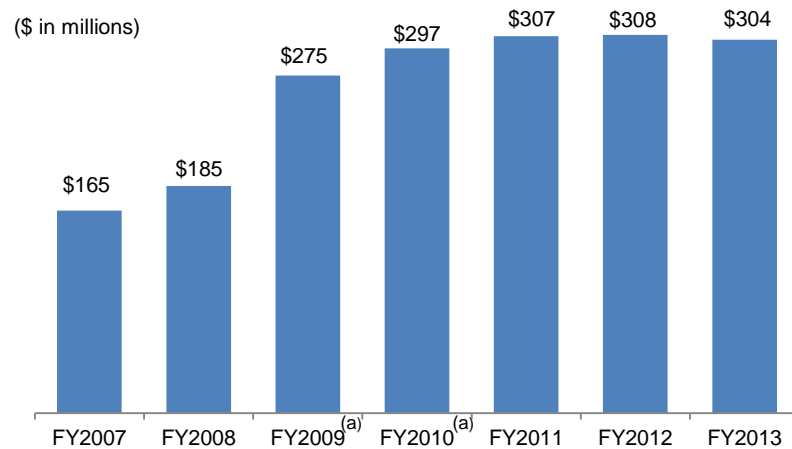

Global Battery Market: Revenue by Battery Type (World), 2010-2016

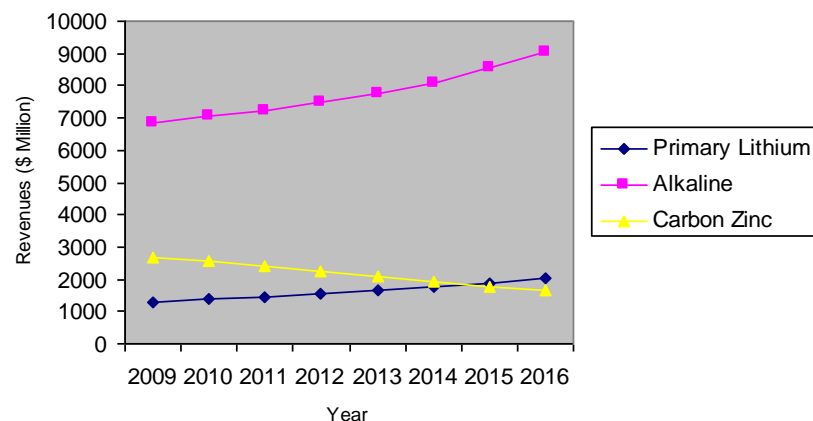

Source: Frost & Sullivan Analysis

(a) Reflects pro forma as if Russell Hobbs merger completed at beginning of respective period.

Global Appliances Industry with a Large Footprint

- Stable, recession-resistant
 - Replacement nature/everyday use products
- Strong portfolio of flagship brands
 - Remington, Black & Decker, George Foreman, Russell Hobbs, Farberware
 - Leading market positions in served categories globally
- Global Appliances has the number 4 position in the global small appliance rankings, overtaking both Conair and Jarden

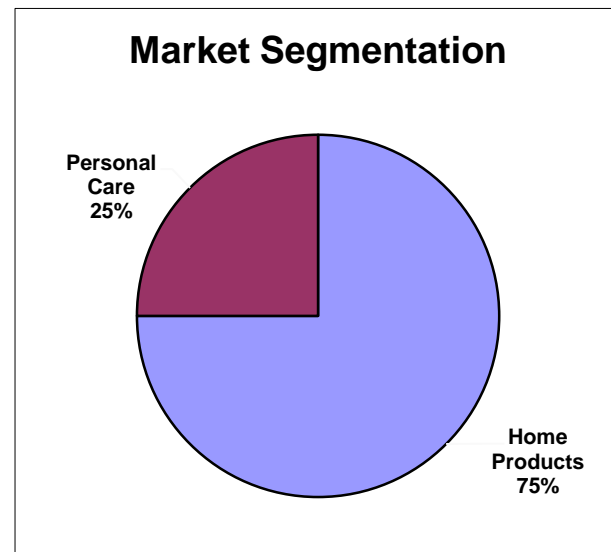
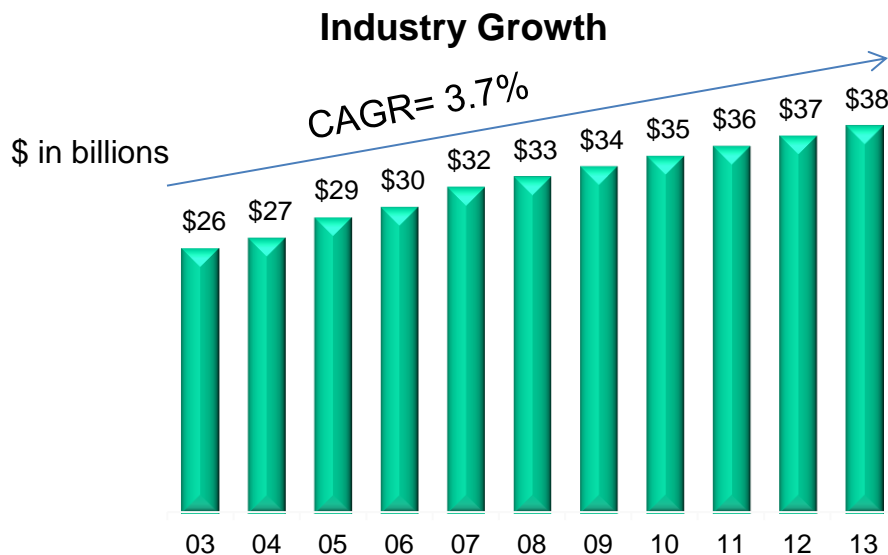

Source: Euromonitor - GA Addressed

Worldwide market share position: Phillips 5.9%, Groupe SEB 5.2%, P&G 5.1%, SPB 4.1%, Conair 3.5% and Jarden 3.5%

Hardware & Home Improvement Segment (HHI)

Kwikset

BALDWIN[®]

WEISER

Pfister[™]

STANLEY

**National
Hardware[™]**

FANAL[®]

EZSET



HHI Segment Overview

Business Description

- Five consecutive quarters of YOY net sales and adjusted EBITDA increases since December 17, 2012 acquisition
- Integration progressed smoothly and is now complete
 - Additional synergy savings identified in next few years
- HHI is a leading provider of residential locksets, builders' hardware, and faucets
 - #1 U.S. lockset and #1 Canadian lockset, #1 U.S. luxury hardware, #1 U.S. builders' hardware, #4 U.S. faucets
 - Largest global tubular lock manufacturer (~50 million units/year)
- Diversified product portfolio with well-recognized brands, characterized by outstanding new product innovation and execution
- Large installed base – about 900 million locks/66 million households
- Long-standing and highly collaborative relationships with customers across all channels
- Acquired in April 2012 certain residential assets of Tong Lung, a Taiwan-based private label lock manufacturer and historically a key supplier to HHI

Revenue by Segment (FY 2013)

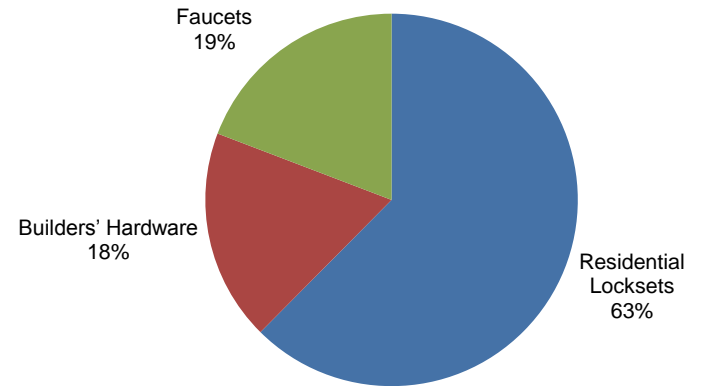

Revenue by Geography (FY 2013)

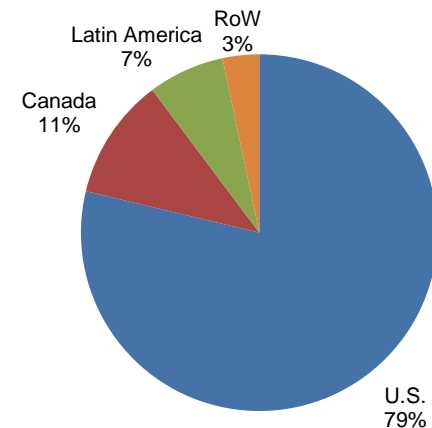



PF FY13 Net Sales: \$1,061 million; Adjusted EBITDA of \$181 million

HHI Has Global Growth Opportunities and Expansion in the Residential/Light Commercial Businesses and Home Automation/Security

- HHI has a diversified existing product portfolio that is complemented by outstanding new product innovation and execution
- Focusing on a number of growth areas, including SmartKey, home automation and security, non-retail plumbing, international (Latin America, Asia and Europe), and light commercial channels

HHI's Three Segments

Segment	Products	Highlights
Residential locksets		<ul style="list-style-type: none"> ▪ Industry-leading functional and style innovation and attractive price point ▪ Expanded sales and lock platform capabilities available through Tong Lung acquisition, allowing for accelerated expansion in international markets
Builders' hardware		<ul style="list-style-type: none"> ▪ High volume order fulfillment capability and supply chain management ▪ Well positioned to benefit from trends in home automation and a recovery in the residential construction market
Faucets		<ul style="list-style-type: none"> ▪ \$200+ million business within attractive \$12.2 billion global market ▪ Trusted brand and products, that deliver a remarkable customer experience: style, innovation, at competitive price points

HHI Game-Changing Technology



What Makes SmartKey Better?

- Drill Resistance
- ANSI Grading
- BumpGuard
- Superior Pick-Resistance

Re-Key as Easy as 1-2-3



THE KEY EVOLVED.



Your Smartphone is Now Your Key

- Mobile App Convenience
- Share eKeys via Smartphone
- No Smartphone? No Problem. Same touch to open convenience with the fob.



Global Pet Supplies Segment



UNITED WE STAND,
 We stand for better health, better play,
 longer naps and more treats. A higher
 standard for pets of all kinds. UPG is
 committed to bring real solutions to pet
 owners and to make pets happy.

Attractive Global Pet Industry

- Global pet food/supplies industry estimated at \$75 billion in 2012
- Consistent annual growth of 3-5%
- United Pet Group (UPG) addresses a \$21 billion market segment with attractive growth characteristics, high fragmentation and low seasonality

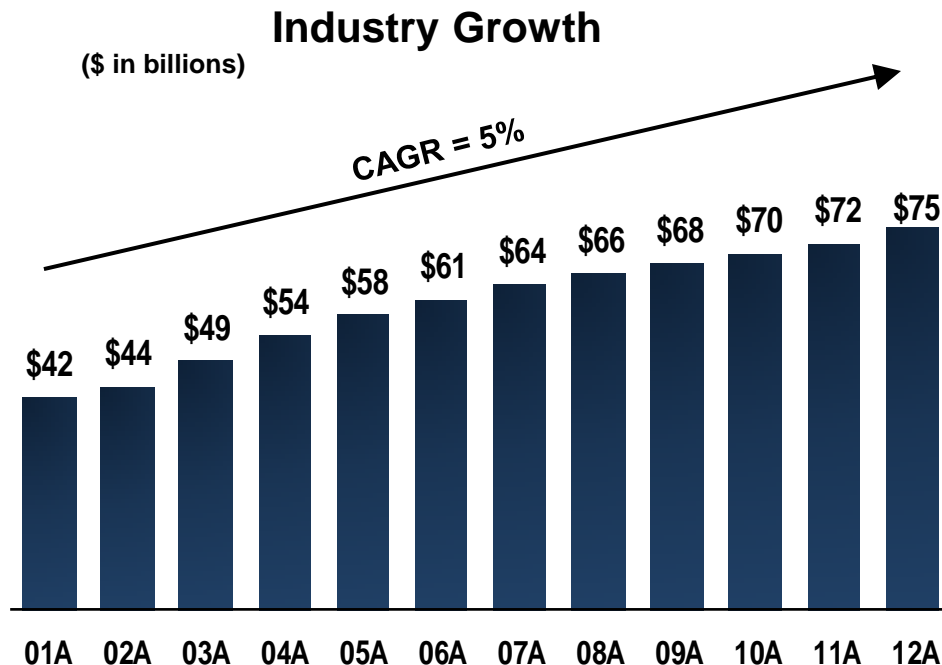

Source: Euromonitor and management estimates

Market Segmentation

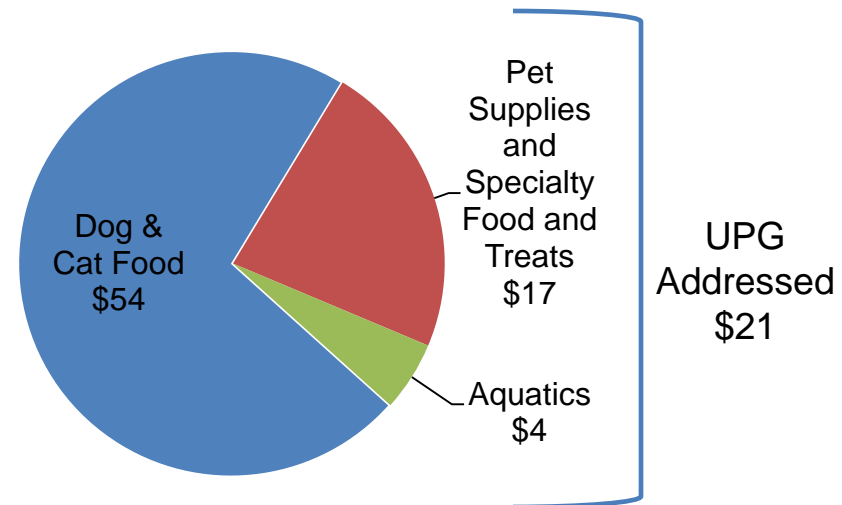

Global Pet Supplies Segment

Sole Player with Global Platform and Presence

Adjusted EBITDA Performance

(\$ in millions)

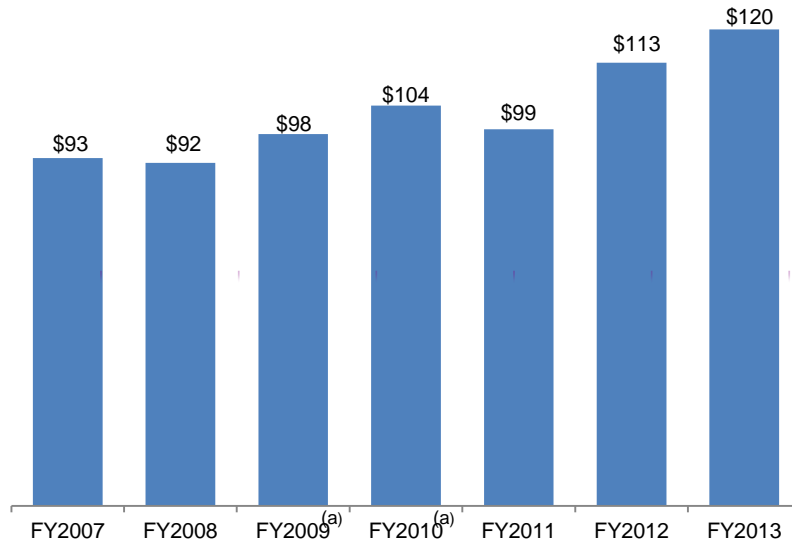

- Another record year in FY13
- Attractive industry trends (e.g., increasing pet ownership/ spending per pet, low seasonality)
- Global market leader in aquatics category with a broad and innovative product line led by the Tetra brand name
- Strong new product pipeline in FY14 and FY15 in both aquatics and companion animals
- \$10-\$15 million of cost-cutting opportunities achieved in FY11- FY12
- Record continuous improvement savings in FY13 more than offset cost increases
- Seeking acquisitive, “tuck-in” growth opportunities in companion animal segment (e.g., FURminator)

Net Sales by Category

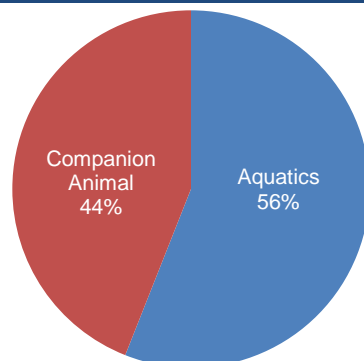

Net Sales by Geography

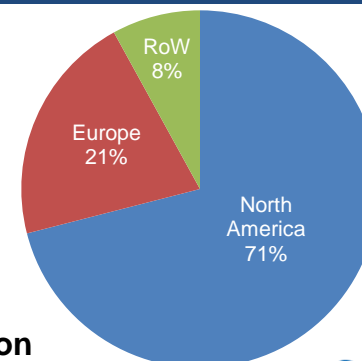

FY13 net sales: \$621.8 million

(a) Reflects pro forma as if Russell Hobbs merger completed at beginning of respective period.

Home and Garden Segment (United Industries)

Industry-Leading Value Brands

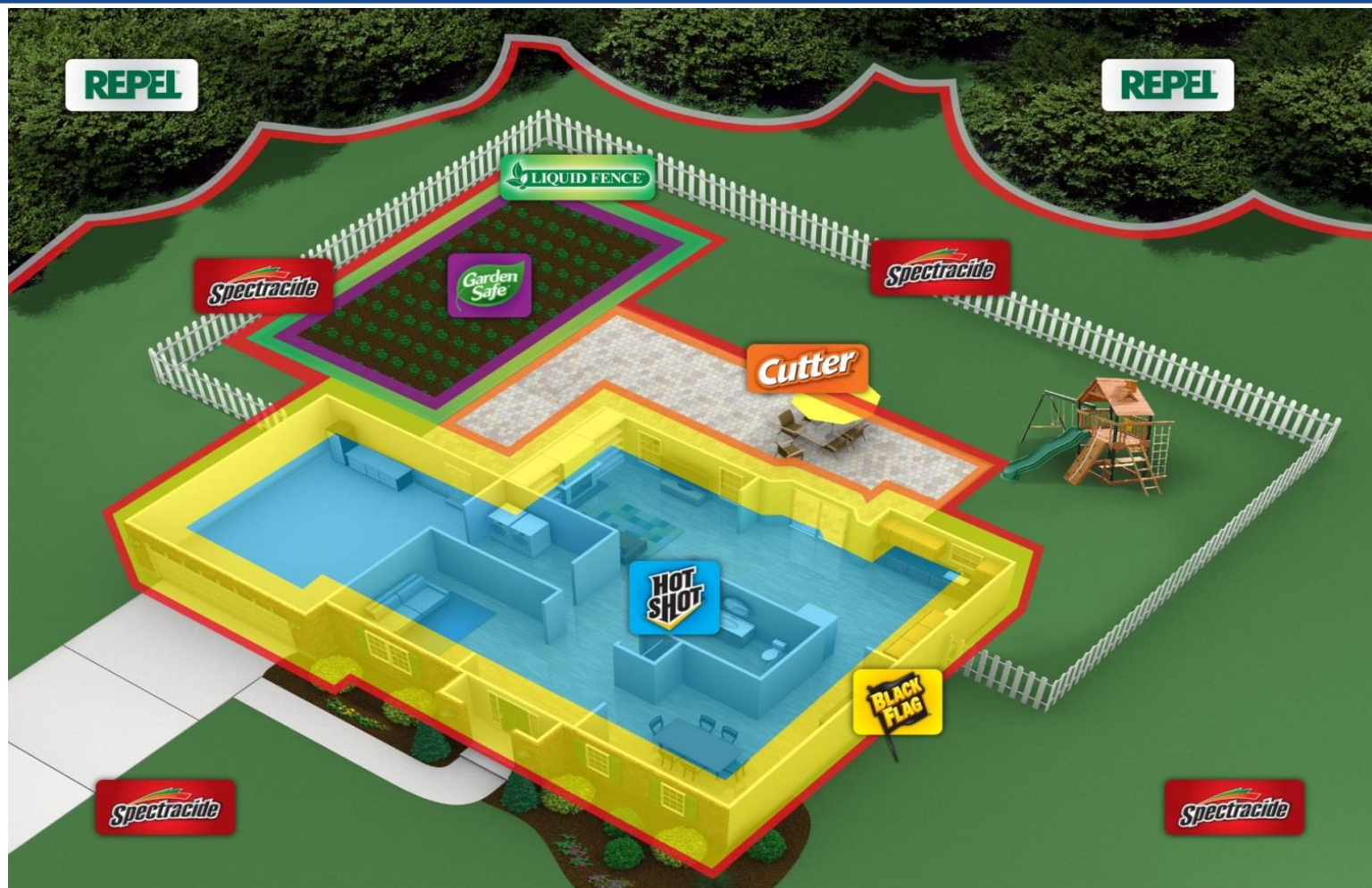

Strong #2 Share in the Industry

U.S. Retail Home and Garden Pest Control Market

\$3 Billion Retail Category (2013 Estimate)

Vendor Market Share Estimate

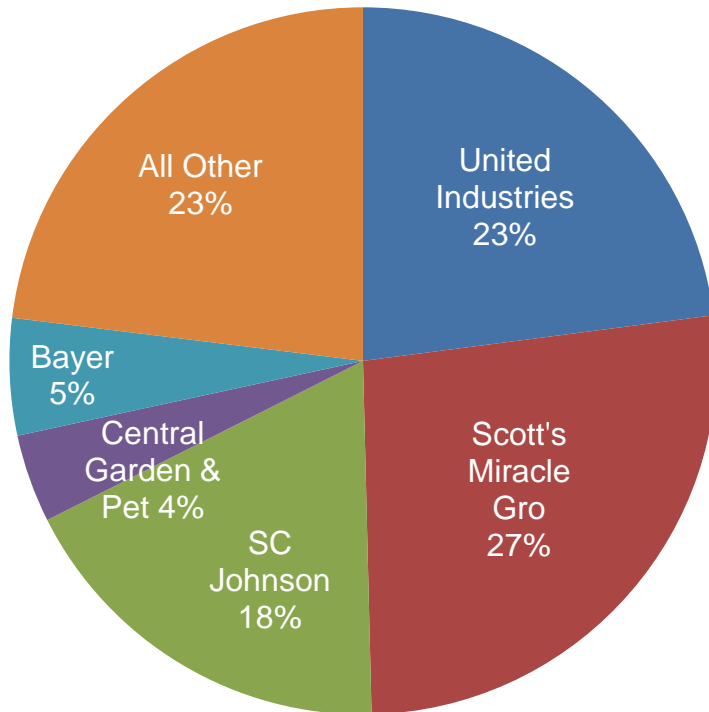

United Industries Share

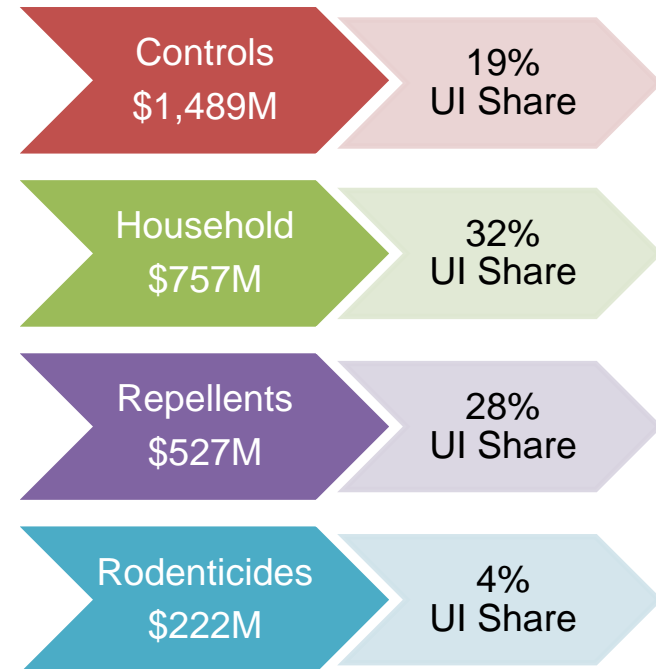

Market Change = -.4% from 2012 to 2013

Source: United Industries Management Estimates

Note: Changes from past estimates due to Nielsen enhancements – WalMart POS and projection methodology improvements

Home and Garden Segment Delivering Robust Growth

Adjusted EBITDA Performance^(a)

(\$ in millions)

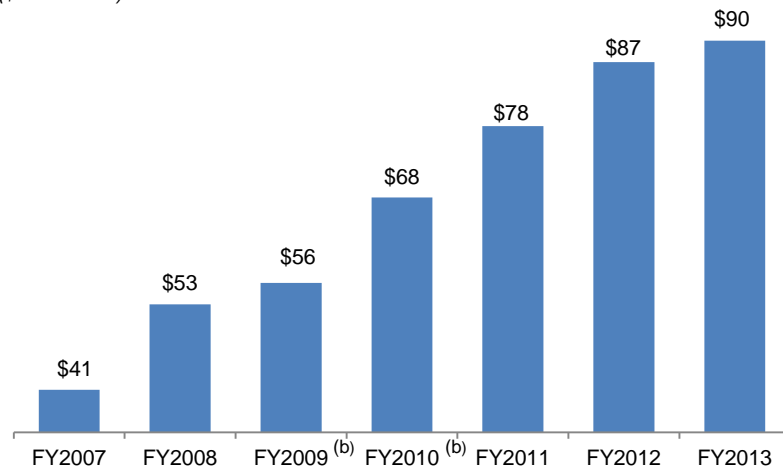

(a) Adj. EBITDA excludes impact of Growing Products division (shut down in Q2 FY09).

(b) Reflects pro forma as if Russell Hobbs merger completed at beginning of respective period.

Drivers of Success

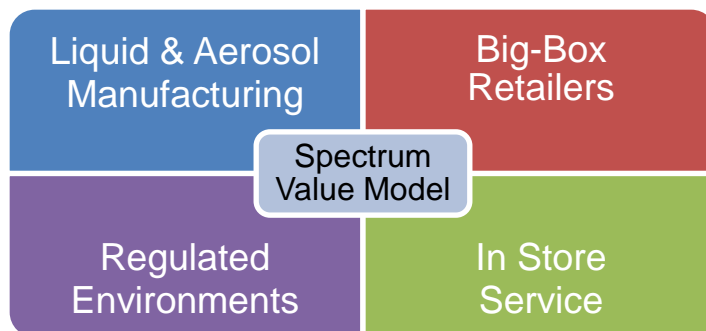

- Another record year in FY13
- Completed accretive Liquid Fence bolt-on acquisition in Q1FY14
- Strong financial results
 - Highest margin Spectrum Brands division
 - Low CapEx requirements
- Attractive industry trends
 - Outdoor living explosion
 - Strong underlying demographic patterns
- Unique competitive environment
 - Few large competitors
 - High entrance barriers
- Solid retail relationships
 - Retail sales team
 - Customer-focused platform sales teams
- Strong operations platform
 - Innovative R&D
 - Low-cost product provider

Committed to value model of providing same performance at less price

Spectrum Brands

REMINGTON®   Russell Hobbs  UNITED PET GROUP, INC

 **Hardware & Home Improvement**  **VARTA**  **RAYOVAC®**

    **ULTRA PRO™**  **REPEL™**   **Kwikset**   **DINGO®**

 **WEISER**
SECURITY & INNOVATION SINCE 1874  **iLIGHT. PRO**
professional hair removal results at home  **MARINELAND.**  **Instant Ocean®**  **STANLEY**  **FURminator®**
PROFESSIONAL PET PRODUCTS  **PRO-SENSE.**

 **NATURE'S MIRACLE**  **BALDWIN**  **8in1®**  **WET2 STRAIGHT**  **PfISTER.**  **EZSET**  **Wild Harvest**  **LITTERMAID®**

 **smooth & silky**   **Sportsman™**  **Real Kill**  **BIRDOLA**
Wildlife feeding specialists  **Jungle**  **Perfect Coat**
Every Dog Has Its Purpose  **TAT**
INSECTICIDES  **PROLINE**
ADVANCED

 **ecOTRITION** Balanced-By-Nature  **National Hardware™**  **PETNATION**  **GEO**
by BLACK & DECKER  **Breadman**  **UltraStop**  **LIQUID FENCE**  **FORTIS**
FURO DESIGN ITALIANO

 **Toastmaster**  **BLACK+DECKER**  **FARBERWARE®**  **FANAL®**  **Juiceman**  **Excel**  **GEORGE FOREMAN**

Fiscal 2014 Outlook

- Spectrum Brands expects to post a 5th consecutive year of record performance, with solid momentum from a record first six months
- Net sales, as reported, expected to increase at approximately the rate of U.S. GDP growth compared to FY13 net sales, including HHI last year on a pro forma basis
- Second half of FY14 should be larger than the record first half, with both the June and September quarters each expected to grow year-over-year
- Free cash flow expected to increase to at least \$350 million, or nearly \$7 per share, up significantly from a record \$254 million, or about \$5 per share, in FY13, and \$208 million, or about \$4 per share, in FY12
- FY14 interest expense is expected to be \$195-\$200 million and depreciation and amortization is expected to be \$190-\$200 million
- FY14 CapEx projected to be approximately \$70-\$75 million, predominantly for cost reduction and new product development
- Term debt reduction expected to be approximately \$250 million in FY14
 - Expected to reduce total leverage to approximately 4.2 times or less at the end of FY14
 - Long-term objective is a total leverage ratio of 2.5 times to 3.5 times
- Pathway seen to approximately \$400 million of free cash flow, or nearly \$8 per share, in FY15 even before factoring in any growth in the business

Quarterly Dividend Started in 2013, Increased 20% in 2014

- Four quarterly common stock dividends of \$0.25 per share paid in March, June, September and December of 2013
- Dividend increased by 20% to \$0.30 per share from \$0.25, effective with quarterly payment in March 2014
 - Higher rate reaffirms the Company's consistent and ongoing ability to generate strong free cash flow and its commitment to deliver attractive returns to its shareholders
- Future opportunity to raise dividend further will be evaluated based upon free cash flow growth
- One-time, special dividend of \$1.00 per share paid on September 18, 2012 to shareholders of record on August 27, 2012
- Special dividend recognized strong fiscal 2012 results and allowed shareholders to receive a dividend in fiscal 2012 equivalent to our initial quarterly dividends in 2013
- In future years, payment of special dividend is not anticipated and should not be expected

Spectrum Brands

REMINGTON



Russell Hobbs

united
INDUSTRIES

VARTA



Hardware &
Home Improvement

RAYOVAC

NYSE: SPB

www.spectrumbrands.com

investorrelations@spectrumbrands.com

david.prichard@spectrumbrands.com

Spectrum Brands

REMINGTON® |  Russell Hobbs

united
INDUSTRIES

 **VARTA**



Hardware &
Home Improvement

RAYOVAC.

Appendix

Experienced and Proven Management Team

Name / Position	Years with Company	Background
David R. Lumley Chief Executive Officer & President	8	<ul style="list-style-type: none"> ▪ Elected Chief Executive Officer in April 2010 ▪ Served as Co-COO and President, Global Batteries, Personal Care and Home and Garden segments since January 2007 ▪ Previously served as President, North America since January 2006 ▪ Previously was President, Rubbermaid Home Products North America
Anthony L. Genito Executive Vice President & Chief Financial Officer	9	<ul style="list-style-type: none"> ▪ Joined Company in June 2004 and has held current position since June 2007 ▪ Previously spent 12 years with Schering-Plough in various financial management positions including CFO of International Pharmaceuticals and Global Supply Chain divisions and Corporate Assistant Controller ▪ Prior to joining Schering-Plough spent 12 years with Deloitte & Touche in the Accounting and Audit function
Andreas Rouvé Chief Operating Officer & President, International	11	<ul style="list-style-type: none"> ▪ Elected Chief Operating Officer, effective February 2014, and continues as President, International ▪ Promoted to President of Spectrum Brands' international activities in January 2013 ▪ Joined Spectrum Brands in 2002 as Chief Financial Officer of the European Battery division ▪ Since 2007, he served as Managing Director of Spectrum Brands' European Battery and Personal Care business and integrated the European Home Appliance business in 2010 and the Pet activities in 2011 ▪ Previously, he worked 13 years with VARTA AG in a variety of management positions, including Chief Financial Officer of VARTA Portable Batteries from 1999 to 2002, Managing Director Asia from 1997 to 1999 and Director of Finance of 3C Alliance L.L.P., a U.S. joint venture of VARTA, Duracell and Toshiba, from 1995 to 1997.
Nathan E. Fagre Senior Vice President, General Counsel & Secretary	3	<ul style="list-style-type: none"> ▪ Joined Company as Vice President, General Counsel and Secretary in January 2011 ▪ Promoted to Senior Vice President, General Counsel and Secretary in May 2012 ▪ Previously served as Senior Vice President, General Counsel and Secretary for ValueVision Media, Inc. from May 2000 until January 2011 ▪ Prior to joining ValueVision, he served as Senior Vice President, General Counsel and Secretary for the exploration and production division of Occidental Petroleum Corporation, from May 1995 until April 2000 ▪ Before joining Occidental Petroleum Corporation, in private law practice with Sullivan & Cromwell, LLP and Gibson, Dunn & Crutcher, LLP

HHI Group Formation

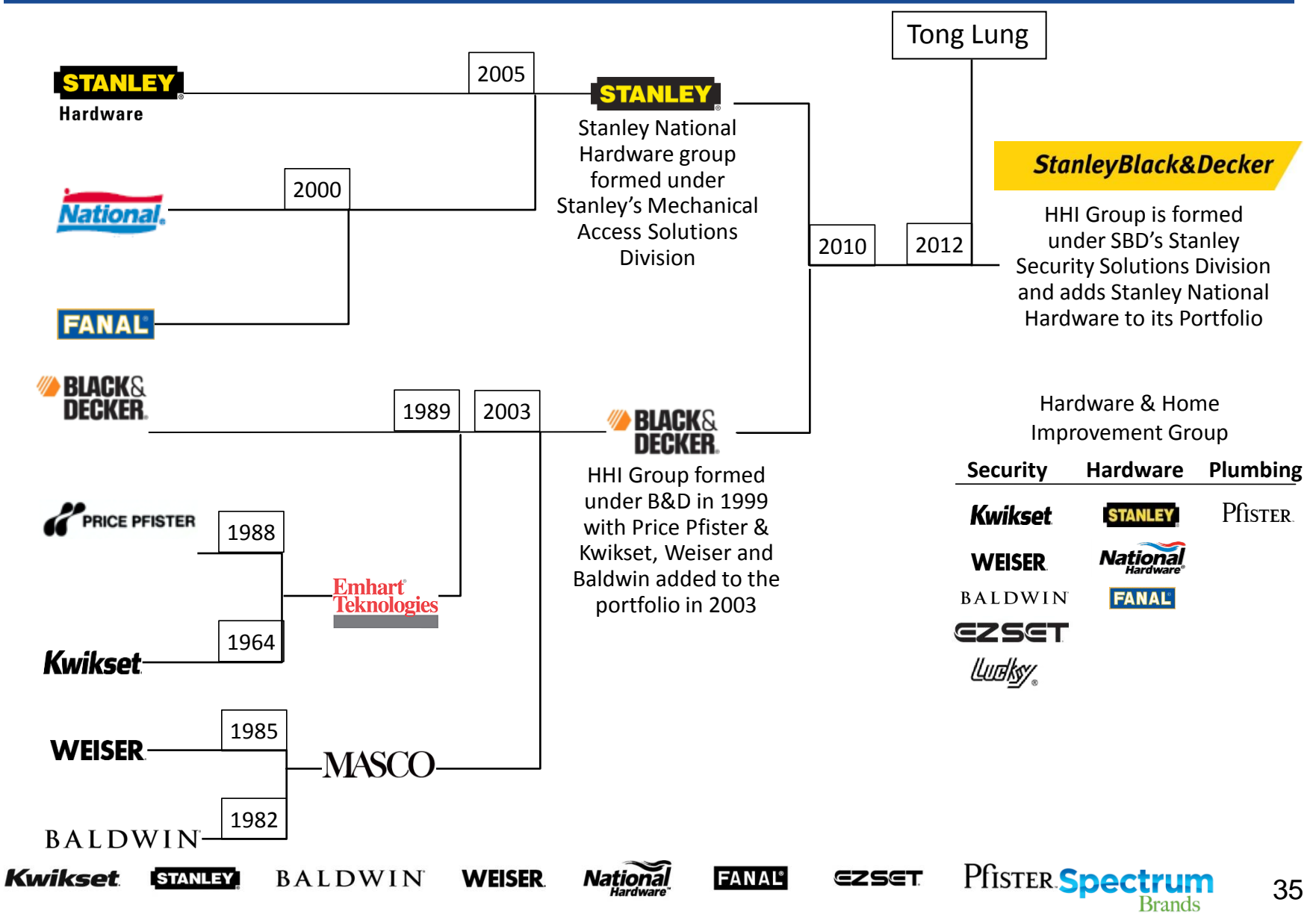

HHI Group Overview

Kwikset	WEISER	BALDWIN	STANLEY Hardware	National Hardware	FANAL	PfISTER
Est. 1946	Est. 1904	Est. 1946	Est. 1843	Est. 1901	Est. 1947	Est. 1910

Revenue by Segment (LTM 6/30)

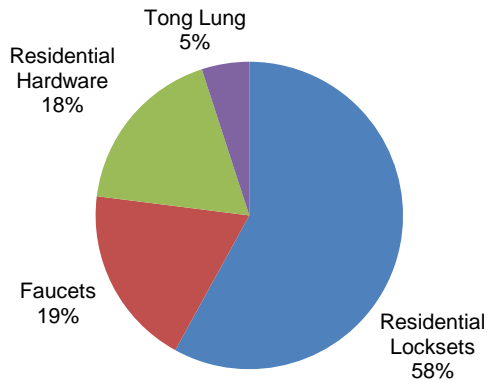

Financial Highlights (LTM 6/30)

Net Sales: \$985 million

Adjusted EBITDA: \$188 million

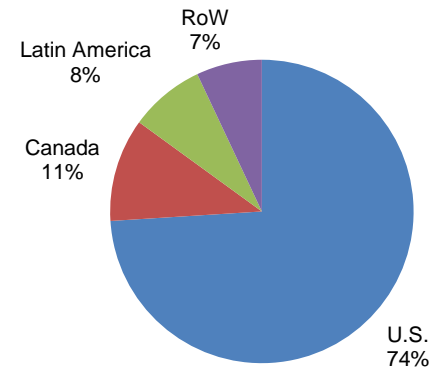

Adjusted EBITDA Margin: 19.1%

Revenue by Geography (LTM 6/30)



Note: Results based on LTM 6/30/12 for HHI. Tong Lung figures as of LTM 12/31/11.

Recognized and Established Brands

	Residential Locksets			Builders' Hardware		Plumbing
Brand	Kwikset	WEISER	BALDWIN	STANLEY National Hardware	FANAL	Pfister
Established	1946	1904	1946	1843 / 1901	1947	1910
Market Position	#1 in U.S. Locksets	#1 in Canada Locksets	#1 in U.S. Luxury Locksets	#1 in U.S. Builders' Hardware	#2 in Mexico Hardware	#4 U.S. in Faucets (#3 in U.S. Retail Channel)
Key Products						
Features	Style, Finish, Innovation, Security, Affordable	Architecturally Influenced Style, Finish, Security, Innovation	Luxury and Quality Leader, Solid Construction, Broad Styles, Functions and Finishes	Broadest Offering, Durable and Consumer Friendly, Superior Sales Replenishment Service Model	Broad Offering, Durable, Security, Affordable	Industry-leading Designs and Styles, Affordable

Leading Market Position

HHI Market Shares

U.S. Residential Lockset Market

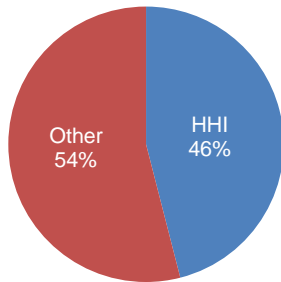

Canada Residential Lockset Market

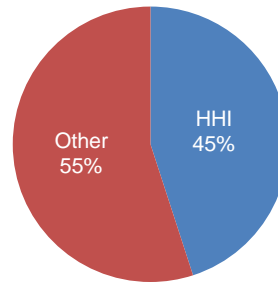

U.S. Builders Hardware Market

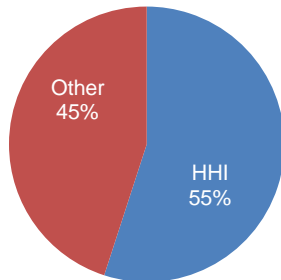

U.S. Luxury Lockset Market

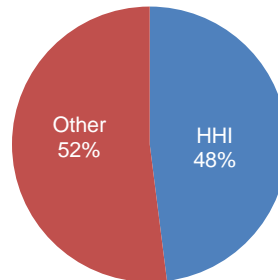

- Largest tubular lock manufacturer globally
- #1 U.S. lockset
- #1 Canadian lockset
- #1 U.S. luxury hardware
- #1 U.S. builders' hardware
- #4 U.S. faucets

Large scale and excellent channel management leading to #1 position with major retailers and top home builders







Strong Distribution and Channel Penetration



Installed base, strong product and brand presence drives pull through demand in all channels

HHI Enjoys Strong Customer Relationships

Dedicated national sales force with robust customer relationships across all distribution channels

Customer	Description of Relationship	Value Proposition
 	<ul style="list-style-type: none"> ▪ Won Home Depot Vendor of the Year in 2011 ▪ Supply chain and fill rate management ▪ Mix management and merchandising ▪ In-store support and training ▪ Wins during recent line reviews 	<ul style="list-style-type: none"> ▪ Install base ▪ Brand strength ▪ Relevant and valued technology ▪ Cost competitive ▪ Category management ▪ Strong OPEX
 	<ul style="list-style-type: none"> ▪ Co-op affiliated independent hardware stores ▪ Supply chain and fill rate management ▪ Manage hardware shelf stock inventory and replenishment orders with industry-leading direct sales force 	<ul style="list-style-type: none"> ▪ Breadth of offering ▪ Direct sales ▪ Automated fulfillment model
   	<ul style="list-style-type: none"> ▪ Regional and large builder account management and selling ▪ Contractual agreements with large accounts ▪ Continuing to gain market share ▪ Primary supplier to top U.S. home builders for several decades 	<ul style="list-style-type: none"> ▪ Brand strength ▪ Style and finish breadth ▪ Technology ▪ Cost competitive ▪ Tiered upgrade options

Evolution of Global Batteries

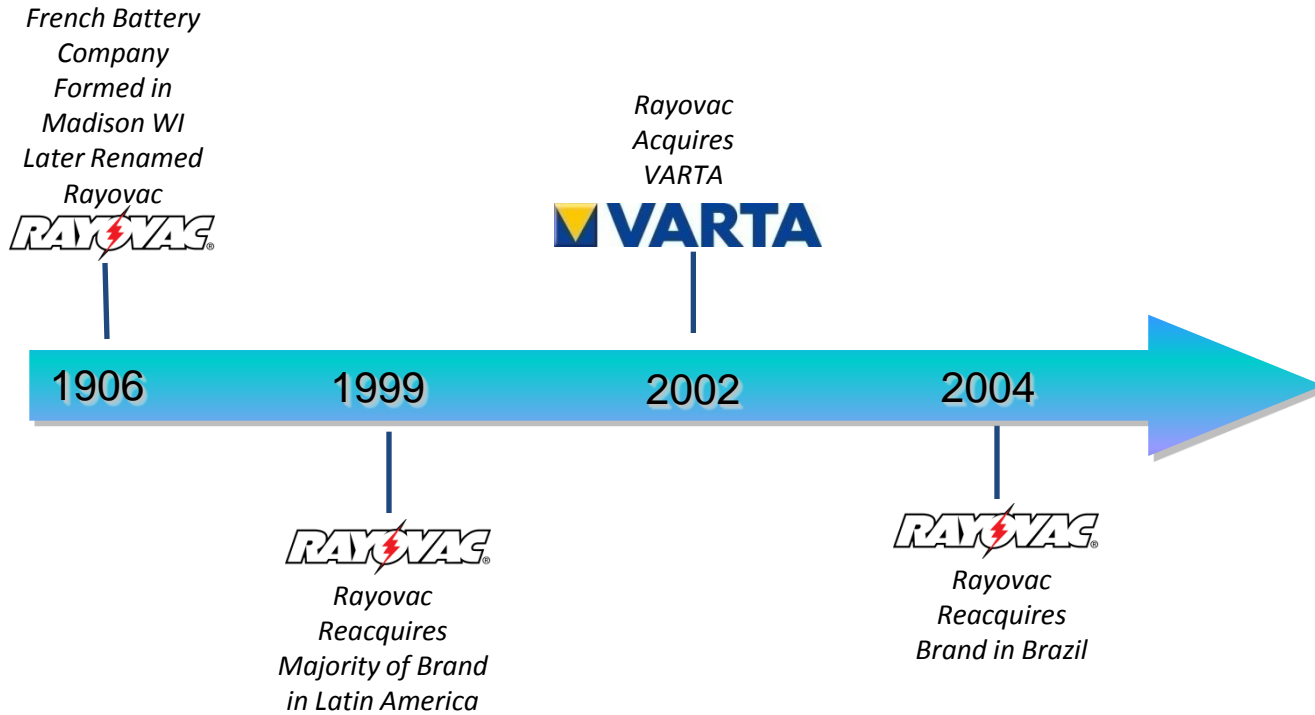

Batteries is an Attractive Segment for SPB Given Market Share Gains & Estimated Organic Growth (Alkaline at 3.5% per Year)

Global Battery Market: Revenue by Battery Type (World), 2010-2016

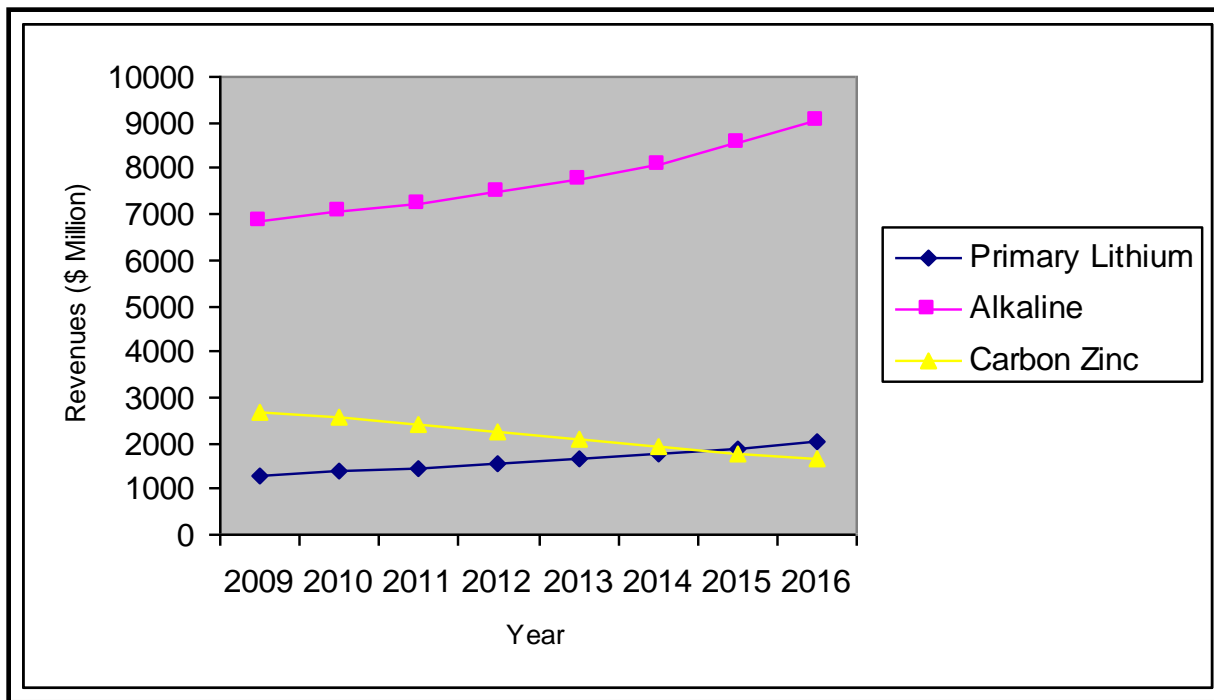







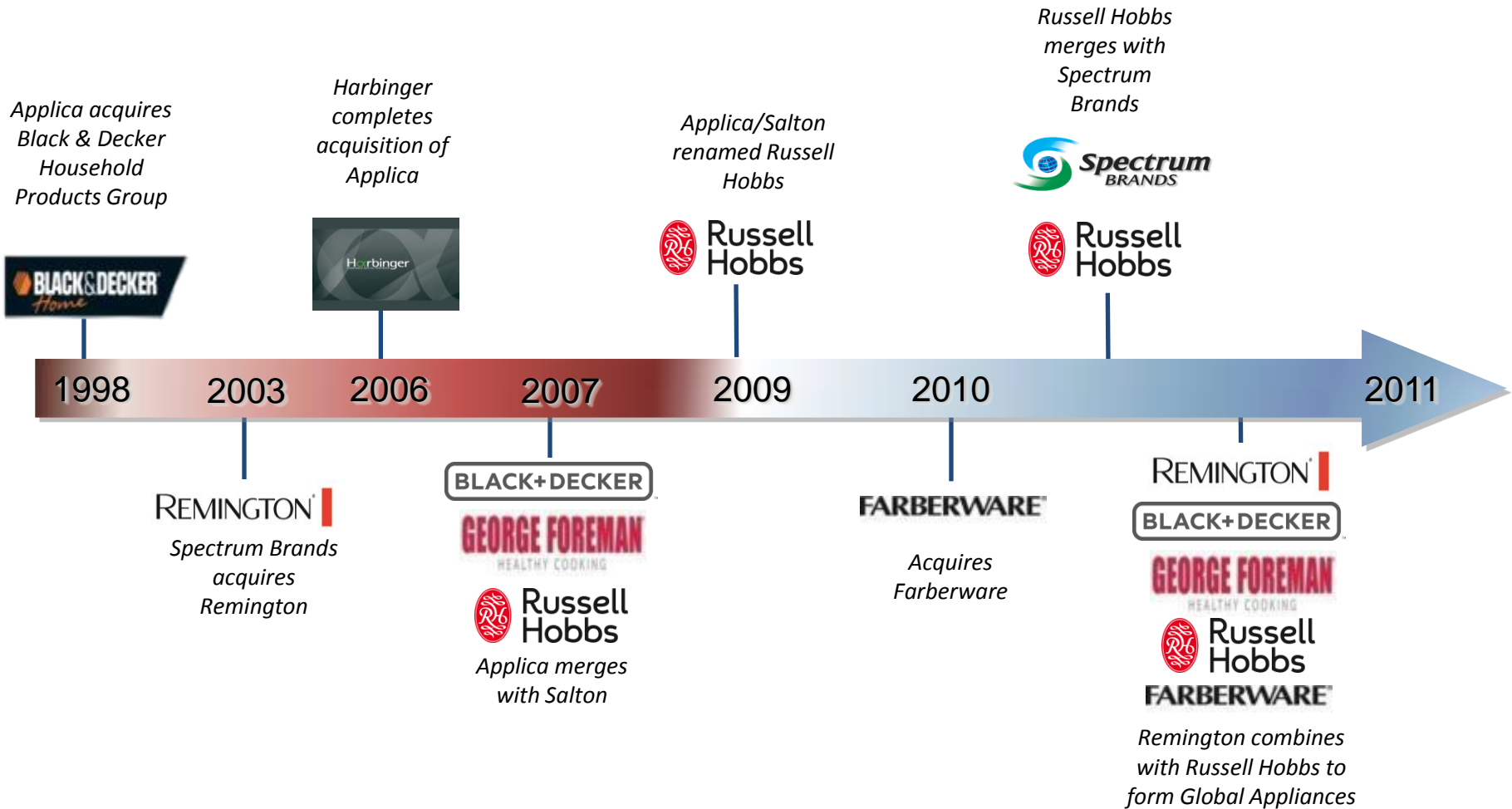



Source: Frost & Sullivan Analysis



Evolution of Global Appliances



Global Appliances – Diversified Product Line-up

Representative Brands	Kitchen Products	Home Products	Personal Care
Product Offerings	<p> <i>Breadman</i> GEORGE FOREMAN FARBERWARE <i>Juiceman</i> BLACK+DECKER   </p> <ul style="list-style-type: none"> ▪ Kettles ▪ Storage and organization products ▪ Food storages ▪ Grills ▪ Toaster ovens ▪ Toasters ▪ Blenders / mixers ▪ Can openers ▪ Coffee makers / grinders ▪ Electric knives ▪ Deep fryers ▪ Food choppers ▪ Food processors ▪ Juicers ▪ Hand mixers ▪ Rice cookers ▪ Steamers ▪ Bread makers ▪ Sandwich makers <div style="display: flex; justify-content: space-around; margin-top: 20px;">   </div>	<p> BLACK+DECKER  Russell Hobbs  </p> <ul style="list-style-type: none"> ▪ Hand-held irons ▪ Vacuum cleaners ▪ Air purifiers ▪ Clothes shavers ▪ Heaters <div style="display: flex; justify-content: space-around; margin-top: 20px;">   </div>	<p> REMINGTON </p> <ul style="list-style-type: none"> ▪ Straighteners, stylers, curling irons ▪ Men's and women's electric shavers & epilators ▪ Men's and women's groomers ▪ Haircut kits ▪ Hand-held hair dryers ▪ Hair setters ▪ i-Light ▪ Women's hair accessories <div style="display: flex; justify-content: space-around; margin-top: 20px;">   </div>





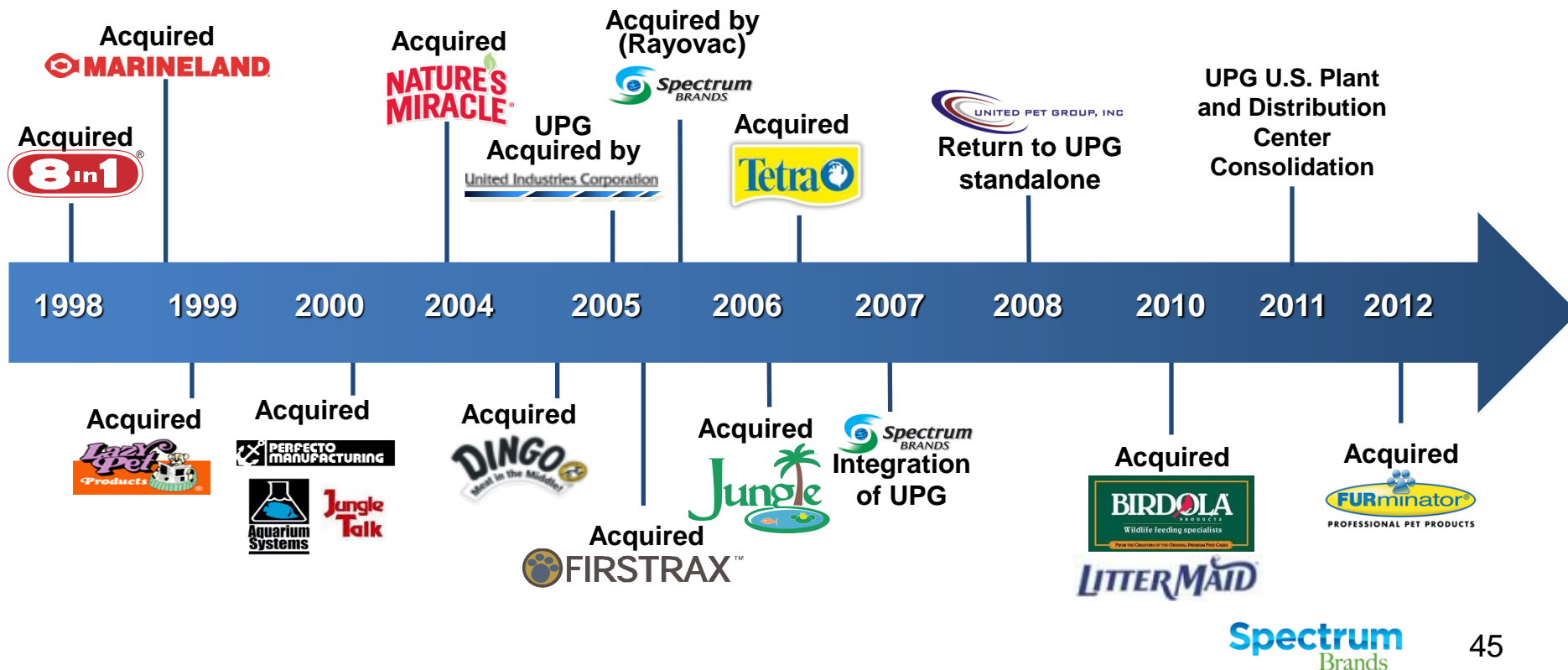

UPG Historical Review: Acquisitions and Integration

- United Pet Group (UPG) was formed in 1998 by TA Associates and between 1999-2006 successfully executed an acquisition/integration strategy within the U.S. pet supplies industry
- Acquired by Spectrum in 2005 with subsequent acquisitions of Tetra and Jungle
- Current opportunity: finalize the consolidation, restart acquisition activity and globalize companion animal segment



UPG: An Impressive Portfolio of Leading Brands

Aquatics

Brand	Product Categories
	7
	5
	3
	2
	2
	3







Companion Animal

Brand	Product Categories
	2
	7
	3
	4
	1
	3









Acquisition: UPG is the Only Global Platform in the Industry

- Dedicated sales, marketing and operations teams in 3 primary geographies: North America, Europe, Pacific Rim
 - Represents 90% of the total pet supply market
- Competitors lack similar infrastructure
- Ideal to execute a global roll-up strategy

Comparative Global Infrastructure

	North America	Latin America	Europe	Japan
	✓	✓	✓	✓
	✓			
	✓	✓		
	✓		✓	
	✓		✓	
	✓			

Long-Standing Global Customer Relationships

Retailer	Length of Relationship	Category Manager/ Advisor Roles
	20 Years	Aquatics Small Animal / Domestic Bird Dog Containment
	> 15 Years	Aquatics Dog & Cat Health and Beauty Aids Rawhide Stain & Odor Control Products
	> 15 Years	Aquatics Dog & Cat Health and Beauty Aids Small Animal / Domestic Bird Stain & Odor Control Products
	> 10 Years	Dog & Cat Health and Beauty Aids Rawhide Small Animal / Domestic Bird Aquatics
	> 10 Years	Aquatics
	> 10 Years	Aquatics
	> 10 Years	Aquatics
	> 20 Years	Aquatics

Highly Recognized and Respected Value Brands

Controls



- Weed & Grass Killers
- Outdoor Insect Control



Household



- Ant, Roach and Wasp Killers
- Indoor Insect Control



Repellents



- Personal and Area Mosquito Repellents
- Yard Treatment Products



Rodenticide & Other



- Mouse / Rat Baits and Traps
- Plant Food



Highlights of Pet and Home and Garden Acquisitions in Late 2011

Black Flag/TAT Brands Acquisition – November 2011

- Black Flag/TAT produces and distributes a line of insecticide products, including liquids, aerosols, baits and traps that control ants, spiders, wasps, bedbugs, fleas and other insects, as well as roach, fly and yellow jacket products for motels
- Accretive transaction strengthens Home & Garden's household insecticide portfolio and increases market share of the US consumer pest control market
 - Black Flag/TAT enhance Spectrum's capabilities to serve consumer marketplace while expanding household insecticide presence in several less developed retail channels
 - Black Flag is one of the oldest brands in the US (dates to 1833) with extraordinary consumer recognition
 - Meaningful manufacturing and distribution synergies



FURminator Acquisition – December 2011

- FURminator is a leading global provider of branded, patented dog and cat grooming products with annual revenue of approximately \$40 million
- Accretive transaction provides Spectrum with a leadership position in global dog and cat grooming category
 - Management expects the global dog/cat grooming category to grow a 3%–4% per year
- \$140 million purchase price (represents approximately 6-7x EBITDA multiple after achieving significant synergies in first 12 to 18 months)
- Acquisition helps provide additional balance in Spectrum's Global Pet Supplies business which includes both aquatics and companion animals



Liquid Fence Accretive, Tuck-in Acquisition

- Liquid Fence is the U.S. leader in the fast-growing consumer animal repellents market
 - Broad and expanding product line, proprietary formulations and solid retailer relationships
 - Flagship product, Liquid Fence Deer & Rabbit Repellent, is the number-one product of its kind in the U.S.
- Consumer animal repellents market growing more than double the rate of the overall lawn and garden category
- Immediately accretive acquisition enhances Home and Garden's margins, already the highest in the Company
 - Synergies will result in an even more attractive multiple paid for Liquid Fence
- New, complementary and leading position in fast-growing segment of the \$1.5 billion U.S. retail lawn and garden controls market
 - Excellent revenue growth potential
 - Strong fit with Home and Garden's core strengths, including liquid production, regulated products and distribution overlap
- Textbook, tuck-in acquisition fits perfectly with stated strategy to seek synergistic, bolt-on businesses
 - Expand product lines with complementary brands and categories
 - Increase and extend market penetration
 - Quick and major manufacturing, distribution and SG&A synergies



Financial Snapshot

Pro forma net sales

(\$ in millions)

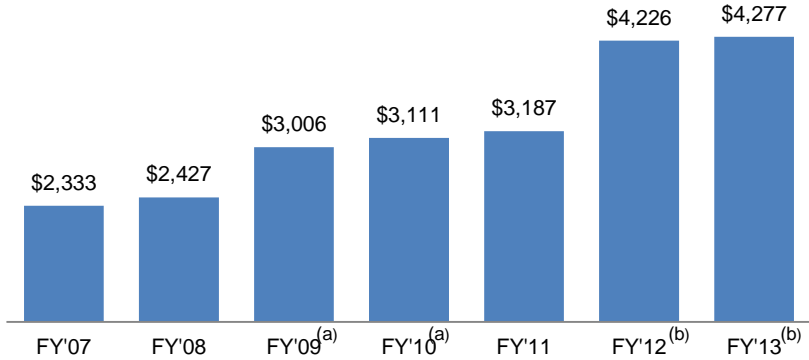

Adjusted EBITDA

(\$ in millions)

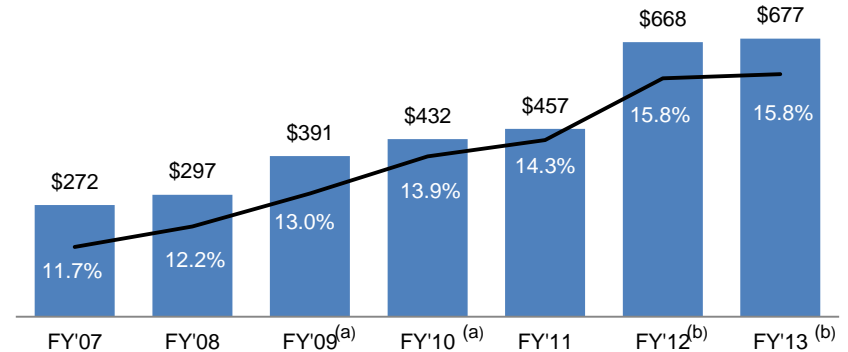

Capital expenditures

(\$ in millions)

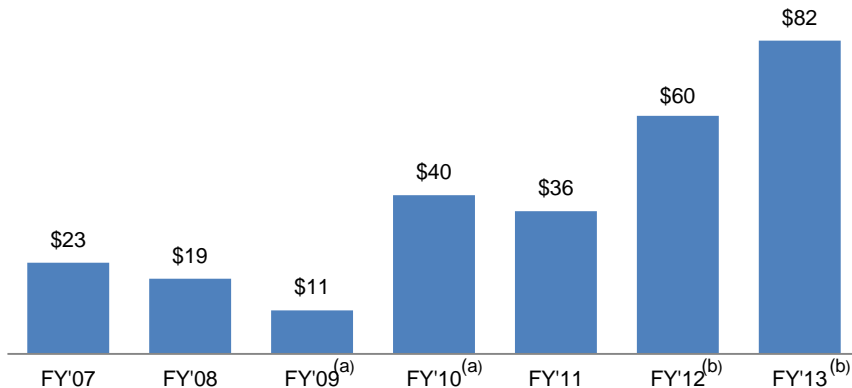

Adjusted EBITDA less capital expenditures

(\$ in millions)

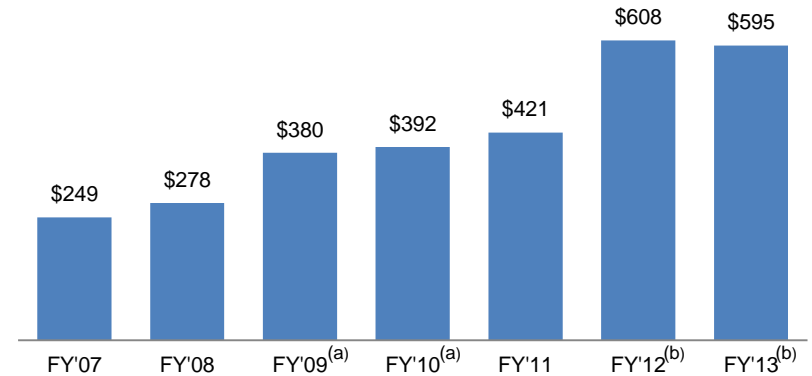

Proven track record of top-line growth and improving profitability

- (a) Reflects pro forma as if Russell Hobbs merger completed at beginning of respective period.
 (b) Reflects pro forma as if HHI acquisition completed at beginning of respective period.

Reconciliation of Adjusted EBITDA

	9/30 FY2008	9/30 FY2009	9/30 FY2010	9/30 FY2011	9/30 FY2012	PF9/30 FY2012	PF9/30 FY2013
Net income	(\$932)	\$943	(\$190)	(\$75)	\$49	\$49	(\$55)
Income tax expense	(10)	74	63	92	60	60	27
Interest expense	229	190	277	208	192	192	376
Depreciation and amortization	85	67	118	135	134	134	184
Unadjusted EBITDA	(\$627)	\$1,274	\$268	\$360	\$435	\$435	\$531
Adjustments to EBITDA:							
Pre-acquisition earnings	0	81	66	0	0	183	30
Restructuring and related charges	39	46	24	29	20	20	34
Acquisition and integration related charges	0	0	39	37	31	31	48
Reorganization items	0	(1,139)	3	0	0	0	0
Loss from discontinued operations	26	86	3	0	0	0	0
Intangible asset impairment	861	34	0	32	0	0	0
Accelerated depreciation and amortization	0	(4)	(3)	(1)	0	0	0
Fresh-start inventory fair value adjustment	0	16	34	0	0	0	0
Russell Hobbs inventory fair value adjustment	0	0	3	0	0	0	0
Other fair value adjustments	0	2	0	0	0	0	31
Venezuelan devaluation	0	0	0	0	0	0	2
Brazilian IPI credit/other	(12)	(6)	(5)	0	0	0	0
Transaction costs	9	0	0	0	0	0	0
EBITDA - Adjusted	\$297	\$391	\$432	\$457	\$485	\$668	\$677

Reconciliation of Adjusted EBITDA by Segment

(\$ in millions)	FY 2013						Consolidated Spectrum
	Global Batteries & Appliances	Global Pet Supplies	Home & Garden Business	Hardware & Home Improvement	Corporate / Unallocated Items ¹		
Net (Loss) Income, as adjusted	\$ 214	\$ 77	\$ 78	\$ 75	\$ (499)	\$ (55)	
Interest expense	-	-	-	-	376	376	
Income tax expense	-	-	-	-	27	27	
Depreciation and amortization	67	30	12	31	44	184	
EBITDA	\$ 281	\$ 107	\$ 89	\$ 107	\$ (52)	\$ 531	
Restructuring and related charges	\$ 15	\$ 11	\$ 1	\$ 6	\$ 1	\$ 34	
Pre-acquisition earnings of HHI	-	-	-	30	-	30	
HHI Business inventory fair value adjustment	-	-	-	31	-	31	
Venezuela devaluation	2	-	-	-	-	2	
Acquisition and integration related charges	6	2	0	7	33	48	
Adjusted EBITDA	\$ 304	\$ 120	\$ 90	\$ 182	\$ (18)	\$ 677	

- (1) It is the Company's policy to record income tax expense and interest expense on a consolidated basis. Accordingly, such amounts are not reflected in the operating results of the operating segments.
- (2) Included within depreciation and amortization is amortization of unearned restricted stock compensation.
- (3) The Pre-acquisition earnings of HHI do not include the TLM Taiwan business as stand alone financial data is not available for the periods presented. The TLM Taiwan business is not deemed material to the Company's operating results.

Table 1
SPECTRUM BRANDS HOLDINGS, INC.
Condensed Consolidated Statements of Operations

For the three and twelve months ended September 30, 2013 and September 30, 2012

(Unaudited)

(\$ in millions, except per share amounts)

	THREE MONTHS			TWELVE MONTHS		
	F2013	F2012	% INC	F2013	F2012	% INC
Net sales	\$ 1,137.7	\$ 832.6	36.6 %	\$ 4,085.6	\$ 3,252.4	25.6 %
Cost of goods sold	735.9	551.1		2,685.3	2,126.9	
Restructuring and related charges	5.3	1.5		10.0	9.8	
Gross profit	396.5	280.0	41.6 %	1,390.3	1,115.7	24.6 %
Selling	172.0	129.7		637.0	521.2	
General and administrative	88.8	60.7		286.4	218.8	
Research and development	11.8	9.3		43.3	33.1	
Acquisition and integration related charges	7.9	10.4		48.4	31.1	
Restructuring and related charges	1.0	2.3		24.0	9.7	
Total operating expenses	281.5	212.4		1,039.1	813.9	
Operating income	115.0	67.6		351.2	301.8	
Interest expense	183.9	41.8		375.6	191.9	
Other (income) expense, net	(4.5)	(1.3)		3.5	0.9	
(Loss) income from continuing operations before income taxes	(64.4)	27.1		(27.9)	109.0	
Income tax (benefit) expense	(27.6)	21.6		27.4	60.4	
Net (loss) income	(36.8)	5.5		(55.3)	48.6	
Less: Net loss attributable to noncontrolling interest, net of tax	(0.1)	—		(0.1)	—	
Net (loss) income attributable to controlling interest	\$ (36.7)	\$ 5.5		\$ (55.2)	\$ 48.6	
Average shares outstanding (a)	52.2	51.4		52.0	51.6	
Basic (loss) income per share attributable to controlling interest	\$ (0.70)	\$ 0.11		\$ (1.06)	\$ 0.94	
Average shares and common stock equivalents outstanding (a) (b)	52.2	53.1		52.0	53.3	
Diluted (loss) income per share attributable to controlling interest	\$ (0.70)	\$ 0.10		\$ (1.06)	\$ 0.91	
Cash dividends declared and paid per common share	\$ 0.25	\$ 1.00		\$ 0.75	\$ 1.00	

(a) Per share figures calculated prior to rounding.

(b) For the three and twelve months ended September 30, 2013, we have not assumed the exercise of common stock equivalents as the impact would be antidilutive.

Table 2
SPECTRUM BRANDS HOLDINGS, INC.

Supplemental Financial Data

As of and for the three and twelve months ended September 30, 2013 and September 30, 2012

(Unaudited)

(\$ in millions)

<u>Supplemental Financial Data</u>	<u>F2013</u>		<u>F2012</u>		
Cash and cash equivalents	\$	207.3	\$	158.0	
Trade receivables, net	\$	481.3	\$	335.3	
Days Sales Outstanding (a)		36		33	
Inventory	\$	632.9	\$	452.6	
Inventory Turnover (b)		4.0		4.1	
Total debt	\$	3,218.9	\$	1,669.3	
		<u>THREE MONTHS</u>		<u>TWELVE MONTHS</u>	
<u>Supplemental Cash Flow Data</u>	<u>F2013</u>		<u>F2012</u>		
Depreciation and amortization, excluding amortization of debt issuance costs	\$	51.0	\$	42.7	\$ 133.8
Capital expenditures	\$	36.8	\$	13.7	\$ 46.8
		<u>THREE MONTHS</u>		<u>TWELVE MONTHS</u>	
<u>Supplemental Segment Sales & Profitability</u>	<u>F2013</u>		<u>F2012</u>		
<u>Net Sales</u>					
Global Batteries & Appliances	\$	577.3	\$	580.0	\$ 2,249.9
Global Pet Supplies		165.2		166.5	621.8
Home and Garden Business		101.4		86.1	390.6
Hardware & Home Improvement		293.8		—	869.6
Total net sales	\$	1,137.7	\$	832.6	\$ 3,252.4
<u>Segment Profit</u>					
Global Batteries & Appliances	\$	55.8	\$	58.7	\$ 244.4
Global Pet Supplies		28.3		28.1	91.1
Home and Garden Business		18.8		13.1	78.5
Hardware & Home Improvement		42.2		—	88.7
Total segment profit		145.1		99.9	495.8
Corporate		15.9		18.1	62.1
Acquisition and integration related charges		7.9		10.4	48.5
Restructuring and related charges		6.3		3.8	34.0
Interest expense		183.9		41.8	375.6
Other expense (income), net		(4.5)		(1.3)	3.5
(Loss) income from continuing operations before income taxes	\$	(64.4)	\$	27.1	\$ (27.9)
			\$		\$ 109.0

(a) Reflects actual days sales outstanding at end of period.

(b) Reflects cost of sales (excluding restructuring and related charges and HHI Business inventory step-up) during the last twelve months divided by average inventory during the period.

Table 3

SPECTRUM BRANDS HOLDINGS, INC.

**Reconciliation of GAAP Diluted Income (Loss) Per Share to Adjusted Diluted Income Per Share
For the three and twelve months ended September 30, 2013 and September 30, 2012**

(Unaudited)

	THREE MONTHS		TWELVE MONTHS	
	F2013	F2012	F2013	F2012
Diluted (loss) income per share, as reported	\$ (0.70)	\$ 0.10	\$ (1.06)	\$ 0.91
Adjustments, net of tax:				
Pre-acquisition earnings of HHI	—	0.33 (a)	0.06 (a)	0.93 (a)
Acquisition and integration related charges	0.10 (b)	0.13 (d)	0.59 (c)	0.38 (e)
Restructuring and related charges	0.08 (f)	0.04 (g)	0.42 (f)	0.24 (g)
Debt refinancing costs	1.49 (h)	—	1.85 (i)	0.33 (j)
Purchase accounting inventory adjustment	—	—	0.38 (k)	—
Venezuela devaluation	—	—	0.02 (l)	—
Income taxes	(0.09) (m)	0.23 (n)	0.70 (m)	0.42 (n)
Share dilution assumption	— (o)	—	0.02 (o)	—
	1.58	0.73	4.04	2.30
Diluted income per share, as adjusted	<u>\$ 0.88</u>	<u>\$ 0.83</u>	<u>\$ 2.98</u>	<u>\$ 3.21</u>

(a) For the twelve months ended September 30, 2013, and the three and twelve months ended September 30, 2012, reflects \$3.2 million, \$17.2 million and \$49.5 million, net of tax, of pre-acquisition earnings related to the acquired HHI business. The Pre-acquisition earnings of HHI do not include the TLM Taiwan business as stand alone financial data is not available for the periods presented. The TLM Taiwan business is not deemed material to the Company's operating results.

(b) For the three months ended September 30, 2013, reflects \$5.1 million, net of tax, of Acquisition and integration related charges, as follows: (i) \$3.8 million related to the acquisition of the HHI Business, consisting primarily of legal and professional fees; (ii) \$0.5 million related to the acquisition of FURminator, consisting of integration costs; (iii) \$0.5 million related to the merger with Russell Hobbs, consisting of integration costs; and (iv) \$0.3 million related to the acquisition of Shaser and other acquisition activity, consisting of legal and professional fees.

(c) For the twelve months ended September 30, 2013, reflects \$31.5 million, net of tax, of Acquisition and integration related charges, as follows: (i) \$24.0 million related to the acquisition of the HHI Business, consisting primarily of legal and professional fees; (ii) \$3.1 million related to the acquisition of Shaser, consisting of integration and legal and professional fees; (iii) \$2.3 million related to the merger with Russell Hobbs, consisting of integration costs; and (iv) \$2.1 million related to the acquisition of FURminator and other acquisition activity, consisting of integration costs.

(d) For the three months ended September 30, 2012, reflects \$6.8 million, net of tax, of Acquisition and integration related charges as follows: (i) \$2.6 million related to the merger with Russell Hobbs which consisted primarily of integration costs; (ii) \$1.0 million related to the acquisition of FURminator, consisting primarily of integration costs; (iii) \$1.0 million related to the acquisition of Black Flag, consisting primarily of integration costs; and (iv) \$2.2 million related to other acquisition activity, consisting primarily of legal and professional fees.

(e) For the twelve months ended September 30, 2012, reflects \$20.2 million, net of tax, of Acquisition and integration related charges as follows: (i) \$10.1 million related to the merger with Russell Hobbs which consisted primarily of integration costs; (ii) \$5.2 million related to the acquisition of FURminator, consisting primarily of integration costs and legal and professional fees; and (iii) \$4.9 million related to the acquisition of Black Flag and other acquisition activity, consisting primarily of legal and professional fees.

(f) For the three and twelve months ended September 30, 2013, reflects \$4.1 million and \$22.1 million, net of tax, respectively, of Restructuring and related charges primarily related to the Global Cost Rationalization Initiatives announced in Fiscal 2013 and the Global Cost Reduction Initiatives announced in Fiscal 2009.

(g) For the three and twelve months ended September 30, 2012, reflects \$2.4 million and \$12.7 million, net of tax, respectively, of Restructuring and related charges primarily related to the Global Cost Reduction Initiatives announced in Fiscal 2009.

(h) For the three months ended September 30, 2013, reflects \$79.4 million, net of tax, related to financing fees and the write off of unamortized debt issuance costs in connection with the refinancing of the Company's 9.5% Notes.

(i) For the twelve months ended September 30, 2013, reflects \$98.2 million, net of tax, related to financing fees and the write off of unamortized debt issuance costs in connection with the extinguishment of the Company's 9.5% Notes and the replacement of the Company's Term Loan and the issuance of the 6.375% Notes and 6.625% Notes in connection with the acquisition of the HHI Business.

(j) For the twelve months ended September 30, 2012, reflects \$17.9 million, net of tax, related to financing fees and the write off of unamortized debt issuance costs in connection with the extinguishment of the Company's 12% Notes during the fiscal quarter ended April 1, 2012.

(k) For the twelve months ended September 30, 2013, reflects a \$20.2 million, net of tax, non-cash increase to cost of goods sold related to the sales of inventory that was subject to fair value adjustments in conjunction with the acquisition of the HHI Business.

(l) For the twelve months ended September 30, 2013, reflects an adjustment of \$1.3 million, net of tax, related to the devaluation of the Venezuelan Bolivar Fuerte.

(m) For the three and twelve months ended September 30, 2013, reflects adjustments to income tax expense of \$(5.0) million and \$37.1 million, respectively, to exclude the impact of the valuation allowance against deferred taxes and other tax related items in order to reflect a normalized ongoing effective tax rate.

(n) For the three and twelve months ended September 30, 2012, reflects adjustments to income tax expense of \$12.1 million and \$22.2 million, respectively, to exclude the impact of the valuation allowance against deferred taxes and other tax related items in order to reflect a normalized ongoing effective tax rate.

(o) Adjustment to reflect the fully diluted net income per share, as adjusted. The US GAAP diluted net loss per share calculation does not take into account the dilutive impact of common stock equivalents as these would be antidilutive given the net loss reported. Therefore the diluted net loss per share is decreased when the dilutive impact of common stock equivalents are taken into consideration. Full dilution is used for this calculation as a result of the adjusted net income.

Table 4
SPECTRUM BRANDS HOLDINGS, INC.
Reconciliation of GAAP Net Income (Loss) to Adjusted EBITDA
For the three months ended September 30, 2013
(Unaudited)
(\$ in millions)

	<u>Global Batteries & Appliances</u>	<u>Global Pet Supplies</u>	<u>Home & Garden Business</u>	<u>Hardware & Home Improvement</u>	<u>Corporate / Unallocated Items (a)</u>	<u>Consolidated Spectrum Brands Holdings, Inc.</u>
Net income (loss) attributable to controlling interest, as adjusted (a)	\$ 54.9	\$ 25.9	\$ 18.7	\$ 38.3	\$ (174.5)	\$ (36.7)
Net loss attributable to non-controlling interest	(0.1)	—	—	—	—	(0.1)
Net income (loss) as adjusted (a)	54.8	25.9	18.7	38.3	(174.5)	(36.8)
Income tax benefit	—	—	—	—	(27.6)	(27.6)
Interest expense	—	—	—	—	183.9	183.9
Acquisition and integration related charges	1.7	0.6	—	3.3	2.3	7.9
Restructuring and related charges	3.3	1.7	0.1	1.2	—	6.3
Adjusted EBIT	59.8	28.2	18.8	42.8	(15.9)	133.7
Depreciation and amortization (b)	17.5	7.6	3.0	11.6	11.3	51.0
Adjusted EBITDA	\$ 77.3	\$ 35.8	\$ 21.8	\$ 54.4	\$ (4.6)	\$ 184.7

Note: Amounts calculated prior to rounding.

(a) It is the Company's policy to record Income tax expense and Interest expense on a consolidated basis. Accordingly, such amounts are not reflected in the results of the operating segments and are presented within Corporate/Unallocated Items.

(b) Included within depreciation and amortization is amortization of unearned restricted stock compensation.

Table 4
SPECTRUM BRANDS HOLDINGS, INC.
Reconciliation of GAAP Net Income (Loss) to Adjusted EBITDA
For the year ended September 30, 2013
(Unaudited)
(\$ in millions)

	<u>Global Batteries & Appliances</u>	<u>Global Pet Supplies</u>	<u>Home & Garden Business</u>	<u>Hardware & Home Improvement</u>	<u>Corporate / Unallocated Items (a)</u>	<u>Consolidated Spectrum Brands Holdings, Inc.</u>
Net income (loss) attributable to controlling interest, as adjusted (a)	\$ 214.1	\$ 77.0	\$ 77.7	\$ 75.0	\$ (499.0)	\$ (55.2)
Net loss attributable to non-controlling interest	(0.5)	—	—	0.4	—	(0.1)
Net income (loss), as adjusted (a)	213.6	77.0	77.7	75.4	(499.0)	(55.3)
Pre-acquisition earnings of HHI (b)	—	—	—	30.3	—	30.3
Income tax expense	—	—	—	—	27.4	27.4
Interest expense	—	—	—	—	375.6	375.6
Acquisition and integration related charges	6.1	2.2	0.1	7.4	32.6	48.4
Restructuring and related charges	14.8	11.2	0.6	6.2	1.2	34.0
HHI Business inventory fair value adjustment	—	—	—	31.0	—	31.0
Venezuela devaluation	2.0	—	—	—	—	2.0
Adjusted EBIT	236.5	90.4	78.4	150.3	(62.2)	493.4
Depreciation and amortization (c)	67.2	29.6	11.7	31.3	43.9	183.7
Adjusted EBITDA	\$ 303.7	\$ 120.0	\$ 90.1	\$ 181.6	\$ (18.3)	\$ 677.1

Note: Amounts calculated prior to rounding.

(a) It is the Company's policy to record Income tax expense and Interest expense on a consolidated basis. Accordingly, such amounts are not reflected in the results of the operating segments and are presented within Corporate/Unallocated Items.

(b) The Pre-acquisition earnings of HHI do not include the TLM Taiwan business as stand alone financial data is not available for the periods presented. The TLM Taiwan business is not deemed material to the Company's operating results.

(c) Included within depreciation and amortization is amortization of unearned restricted stock compensation.

Table 4
SPECTRUM BRANDS HOLDINGS, INC.
Reconciliation of GAAP Net Income (Loss) to Adjusted EBITDA
For the three months ended September 30, 2012
(Unaudited)
(\$ in millions)

	<u>Global Batteries & Appliances</u>	<u>Global Pet Supplies</u>	<u>Home & Garden Business</u>	<u>Hardware & Home Improvement</u>	<u>Corporate / Unallocated Items (a)</u>	<u>Consolidated Spectrum Brands Holdings, Inc.</u>
Net income (loss), as adjusted (a)	\$ 55.2	\$ 23.1	\$ 11.9	\$ —	\$ (84.6)	\$ 5.5
Pre-acquisition earnings of HHI (b)	—	—	—	53.0	—	53.0
Income tax benefit	—	—	—	—	21.6	21.6
Interest expense	—	—	—	—	41.8	41.8
Acquisition and integration related charges	3.7	1.8	1.5	—	3.4	10.4
Restructuring and related charges	0.6	3.2	(0.3)	—	0.1	3.8
Adjusted EBIT	59.5	28.1	13.1	53	(17.7)	136.1
Depreciation and amortization (c)	17.6	7.5	4.2	—	13.4	42.7
Adjusted EBITDA	\$ 77.1	\$ 35.7	\$ 17.3	\$ 53.0	\$ (4.3)	\$ 178.8

Note: Amounts calculated prior to rounding.

(a) It is the Company's policy to record Income tax expense and Interest expense on a consolidated basis. Accordingly, such amounts are not reflected in the results of the operating segments and are presented within Corporate/Unallocated Items.

(b) The Pre-acquisition earnings of HHI do not include the TLM Taiwan business as stand alone financial data is not available for the periods presented. The TLM Taiwan business is not deemed material to the Company's operating results.

(c) Included within depreciation and amortization is amortization of unearned restricted stock compensation.

Table 4
SPECTRUM BRANDS HOLDINGS, INC.
Reconciliation of GAAP Net Income (Loss) to Adjusted EBITDA
For the year ended September 30, 2012
(Unaudited)
(\$ in millions)

	<u>Global Batteries & Appliances</u>	<u>Global Pet Supplies</u>	<u>Home & Garden Business</u>	<u>Hardware & Home Improvement</u>	<u>Corporate / Unallocated Items (a)</u>	<u>Consolidated Spectrum Brands Holdings, Inc.</u>
Net income (loss), as adjusted (a)	\$ 221.6	\$ 69.8	\$ 70.6	\$ —	\$ (313.4)	\$ 48.6
Pre-acquisition earnings of HHI (b)	—	—	—	183.1	—	183.1
Income tax expense	—	—	—	—	60.4	60.4
Interest expense	—	—	—	—	191.9	191.9
Acquisition and integration related charges	14.9	5.5	2.1	—	8.6	31.1
Restructuring and related charges	7.6	10.1	0.9	—	0.9	19.5
Adjusted EBIT	244.1	85.4	73.6	183.1	(51.6)	534.6
Depreciation and amortization (c)	63.6	27.7	13.3	—	29.2	133.8
Adjusted EBITDA	\$ 307.7	\$ 113.1	\$ 86.9	\$ 183.1	\$ (22.4)	\$ 668.4

Note: Amounts calculated prior to rounding.

(a) It is the Company's policy to record Income tax expense and Interest expense on a consolidated basis. Accordingly, such amounts are not reflected in the results of the operating segments and are presented within Corporate/Unallocated Items.

(b) The Pre-acquisition earnings of HHI do not include the TLM Taiwan business as stand alone financial data is not available for the periods presented. The TLM Taiwan business is not deemed material to the Company's operating results.

(c) Included within depreciation and amortization is amortization of unearned restricted stock compensation.

Table 5**SPECTRUM BRANDS HOLDINGS, INC.****Pro Forma Net Sales Comparison****For the three and twelve months ended September 30, 2013 and September 30, 2012**

(Unaudited)

(In millions)

	THREE MONTHS			TWELVE MONTHS		
	<u>F2013</u>	<u>F2012</u>	<u>% INC</u>	<u>F2013</u>	<u>F2012</u>	<u>% INC</u>
Spectrum Brands Holdings, Inc. Net sales - as reported	\$ 1,137.7	\$ 832.6	36.6 %	\$ 4,085.6	\$ 3,252.4	25.6 %
HHI pre-acquisition Net sales (a)	—	256.8		191.8	973.6	
Pro Forma Net Sales	<u>\$ 1,137.7</u>	<u>\$ 1,089.4</u>	4.4 %	<u>\$ 4,277.4</u>	<u>\$ 4,226.0</u>	1.2 %

(a) Net sales have been adjusted to reflect the acquisition of HHI as if it occurred at the beginning of each period presented. HHI pre-acquisition Net sales do not include the TLM Taiwan business as stand alone financial data is not available for the periods presented. The TLM Taiwan business is not deemed material to the Company's operating results.

Table 6**SPECTRUM BRANDS HOLDINGS, INC.****Reconciliation of Cash Flow from Operating Activities to Free Cash Flow****For the year ended September 30, 2013**

(Unaudited)

(\$ in millions)

Net Cash provided from Operating Activities	\$	256
Cash interest charges related to refinancing		44
Cash acquisition transaction costs		36
Purchases of property, plant and equipment		<u>(82)</u>
Free Cash Flow	\$	<u>254</u>

Table 7

SPECTRUM BRANDS HOLDINGS, INC.

Reconciliation of Forecasted Cash Flow from Operating Activities to Forecasted Free Cash Flow

For the year ended September 30, 2014

(Unaudited)

(\$ in millions)

Forecasted range:

Net Cash provided from Operating Activities	\$ 420 - 425
Purchases of property, plant and equipment	<u>(70) - (75)</u>
Free Cash Flow	<u>\$ 350</u>